

TUNGSRAM™

Innovation is our heritage
EST. 1896

Automotive Lamp Catalog



2020



Welcome to TUNGSRAM

Tungsrám, one of Europe's most iconic lighting brands, is today an independent, privately-owned company and a leading force in the global lighting market.

OUR STORY

The legal predecessor of Tungsrám, Incandescent Lamps and Electric, Ltd., was founded in **1896**.

Tungsrám contributed to the technological improvement in the lighting and telecommunication industry with significant improvements, such as: the development of the tungsten wire for light bulbs, or the great crystal tungsten filament, which made lamps more dependable and reliable.

In the **1930's**, Tungsrám was the largest light bulb and radio tube manufacturer in Central Europe and the third largest in Continental Europe.

After World War II, beyond keeping up with technological development in the core lighting business, building up large scale television, electron tube production, and making inroads into microelectronics, Tungsrám grew to a provider of vacuum technology machinery and turn-key light source factories.

The Tungsrám name has always been highly respected. The Tungsrám Group, based in Hungary, has been developing and manufacturing premium lighting products for residential, commercial and automotive applications for over a century. This rich heritage has now entered into an exciting new phase in **2018**, following our acquisition of GE Lighting's Europe, Middle East, Africa and Turkey operations, which is now teamed up with GE's former Global Automotive Lighting business.

As we head into the 21st century, Tungsrám is poised to build and supply the best lighting available in terms of quality and dependability for consumers on all continents.



Our company will drive forward the design and development of all kinds of light sources, from traditional technologies to state-of-the-art LED products, and will secure Tungsrám's position as a global force in lighting solutions.

Our manufacturing expertise is based on a tradition of creativity and innovation. The combined knowledge of its 4,000 dedicated employees and 1,600 worldwide vendor partners is the irrefutable force that drives the production in five Europe-based manufacturing facilities.



Tungsrám's range of products are all developed in close collaboration with automotive manufacturers from across the globe

Not only does this guarantee that our products meet the highest quality standards of every make and model of vehicle on the road today, it also means that customers will have access to high-quality, affordable replacement parts.

Tungsrám automotive lamps significantly improve visibility and safety for drivers. Keeping in mind the design principle, „see and be seen,“ Tungsrám automotive lamps significantly improve visibility and safety for drivers. Offering premium special lamp design and basic range, Tungsrám lamps will always provide more light on the road. The premium lamps used in headlight application are also DOT compliant, making their use on US roads legal. The main objective in the development of the premium lamps is to effectively help in improving driving performance at night and in poor visibility conditions, maximizing drivers' visibility and reducing the risk of road accidents.

Our constant quality aim is Zero Defects. This involves designing uncompromising quality into the lamps leading to suitability and reliability with a high standard of quality equalling that of the manufacturing technologies.

Our lamps are manufactured to strict international standards and are appropriately marked in conformance with FMVSS with ANSI standards.

Our renowned automotive lighting ranges include basic and premium lamps for original equipment and aftermarket, and we supply products for all major auto brands.



ISO 9001,
IATF 16949

DOT

DOT compliance,
homologation



Global OEM
customer base



Use of UV cut glass,
safe for use in plastic
headlights



EoLV
compliance

TABLE OF CONTENTS

Introduction	2-3
Table of Contents	4-5
Product Offerings	6-27
Nighthawk™ LED Sealed Beam	6-7
Nighthawk™ LED Fog Lamps	8-9
Nighthawk™ LED Miniatures	10-11
High Intensity Discharge Lamps	12-13
Nighthawk™ Xenon	16-17
Nighthawk™ Platinum	18-19
Nighthawk™	20-21
Long Life	22-23
Standard	24-27
GE - Tungram Cross Reference	28-41
Tungram Packaging	42-43
Lamp Locator	44
Lamp Bases	45
Ordering Information	46-56
Warning & Caution Notices.....	57-58

IMPORTANT NOTICE

This catalog contains accumulated data to December 20, 2019. All values are design or typical values when measured under laboratory conditions. Additional information is constantly being uncovered through research and testing, which may modify the data given herein. Contact us for the latest design data and information. Please be aware that changes may be made to the products listed in this catalog at any time.

The data and suggested applications contained in this catalog, as well as any additional information our representative may be able to furnish, are for general information only and are not intended and should not be taken as representations or warranties.

EIGHT WAYS TO MAKE NIGHT DRIVING BETTER

1. Upgrade to TUNGSRAM NIGHTHAWK™ headlights for improved nighttime driving visibility and safety.
2. Change headlights regularly for optimal night vision.
3. Change headlights in pairs for even illumination on both sides.
4. Check all vehicle lights with every oil change.
5. Check headlight alignment regularly.
6. Clean headlight lenses every time you wash your windshield.
7. Whiter light can help improve contrast to make it easier to distinguish objects at night.



Standard bulb



Nighthawk™ bulb

NIGHTHAWK™ LED Sealed Beam*

- Bright, white light
- Exceptional visibility
- Lasting performance
- DOT compliant

Virtually maintenance-free bright, white light.

Trust the LED replacement that's not only clearer than standard halogen sealed beam headlights, but it's long-lasting, too, at 15,000 hours. Need additional performance assurance? Tungram NIGHTHAWK™ LED Sealed Beams come with a three-year limited warranty.

Tungram takes the requirement to sell DOT-compliant headlamps seriously. You can count on Tungram to deliver products that meet all DOT requirements. Choose our sealed beam replacement system for your LED upgrade, and you can trust that it has the proper quality, making it safe and legal way to enhance your nighttime driving.



*Sealed Beam Replacement



Exceptional light. Exceptional experience.

NIGHTHAWK™ LED

SKU	Lamp Type	Lamps/UOS	UOS/Case	CCT	Direct Replacement
93112881	LED 7" ROUND	1	6	5600K	6012, 6014, 6015, 6016, 6017, H5024, H6024
93112882	LED 5X7	1	6	5600K	6052, 6053, H5054, H6054
93112884	LED 4X6 HIGH	1	6	5600K	4651, H4651, H5051
93112883	LED 4X6 LOW	1	6	5600K	4652, H4656, H5062

Tungram NIGHTHAWK™ LED lights are built tough on the outside to handle any kind of ride in almost any kind of weather. And they're designed smart on the inside for long-lasting performance and style.

LED Low Beam

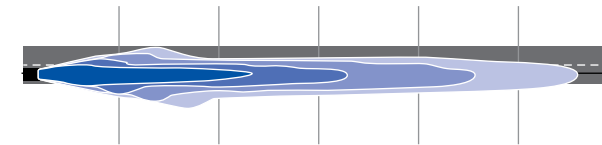

LED High Beam

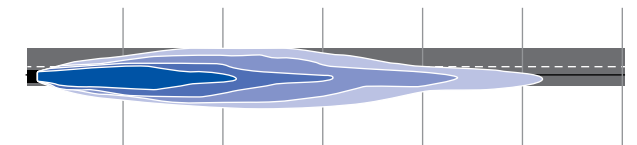

Standard Halogen Low Beam

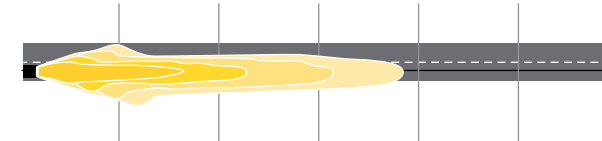

Standard Halogen High Beam

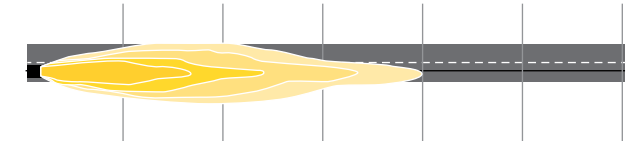

For illustration purposes only



Always replace lamps in pairs

NIGHTHAWK™ LED Fog Lamps

-  Bright, white light
-  Greater visibility
-  Lasting performance

A choice that's clear.
Especially when the air isn't.

The long-lasting performance and enhanced visibility drivers experience with LED Fog Lamps from Tungsram provide peace of mind to help them reach their destination with less worry.

Meanwhile, the convenient replacement these retrofits offer makes the upgrade to LED Fog Lamps easy. The fanless version comes even with a five year limited warranty.



HID headlamp. LED Fog Lamp.

Quality shines through.

Quality is built into every fog lamp Tungsram delivers. Manufactured to exacting and demanding specifications and standards, Tungsram LED Fog Lamps fulfill the needs of drivers around the world.

For fog use only.

LED Fog Lamps

SKU	Lamp Type	Lamps/UOS	UOS/Case	CCT	Direct Replacements
93116081	LED H7	2	4	6000K	H7
93116082	LED H7 FAN	2	4	6000K	H7
93116083	LED H8/H11	2	4	6000K	H8, H11
93116084	LED H8/H11 FAN	2	4	6000K	H8, H11
93116085	LED 9006	2	4	6000K	9006, HB4
93116086	LED 9006 FAN	2	4	6000K	9006, HB4
93117210	Canbus 55W	1	4		



Always replace lamps in pairs

NIGHTHAWK™ LED Miniatures



A big expansion on small lights.

It's an exponential expansion of the lights that may be overlooked but which drivers don't want to be without.

Tungsum has expanded their line of miniatures to 21 lights, providing more fits for more vehicles.

From dome, door and dashboard lights to tail lights and more, this expansion makes a total vehicle upgrade to LED easier than ever.



Performance and quality inside and out.

Tungsum miniature lighting products are crafted for precision, performance, style and long life, so drivers can focus on the road ahead with the confidence they're also being seen by others. The added choices provide added value for every socket.

NIGHTHAWK™ LED Miniatures

SKU	Lamp Type	Lamps/ UOS	UOS/ Case	Direct Replacements
93117370	LED 168, 194, W5W 6K	1	6	168, 194, W5W, W3W, 158, 161, 184, 192
93117373	LED 211-2, 212-2 6K	1	6	211-2, 212-2, 214-2
93116747	LED 3156, 3155 4K	2	6	3156, 3155, P27W
93116746	LED 3156, 3155 6K	2	6	3156, 3155, P27W
93116749	LED 3157, 4157 4K	2	6	3157, 3057, 3457, 4057, 4114, 4157
93116748	LED 3157, 4157 6K	2	6	3157, 3057, 3457, 4057, 4114, 4157
93116741	LED 7440, W21W 4K	2	6	7440, W21W
93116740	LED 7440, W21W 6K	2	6	7440, W21W
93116744	LED 7440R, W21WR	2	6	7440, W21W used behind red lens
93116743	LED 7443, W21/5W 4K	2	6	7443, W21/5W
93116742	LED 7443, W21/5W 6K	2	6	7443, W21/5W
93116745	LED 7443R, W21/5WR	2	6	7443, W21/5W used behind red lens
93117369	LED DE3021, DE3022 6K	1	6	DE3021, DE3022
93117371	LED DE3175 6K	1	6	DE3175
93117372	LED DE3425, C5W 6K	1	6	C5W, DE3425
93116737	LED P21/5W, 1157, 2057 4K	2	6	P21/5W, 1157, 2057, 2357
93116736	LED P21/5W, 1157, 2057 6K	2	6	P21/5W, 1157, 2057, 2357
93116739	LED P21/5W R, 1157R, 2057R	2	6	P21/5W, 1157, 2057, 2357 used behind red lens
93116735	LED P21W, 1156, 1141 4K	2	6	P21W, 1156, 1141
93116734	LED P21W, 1156, 1141 6K	2	6	P21W, 1156, 1141
93116738	LED P21W R, 1156R, 1141R	2	6	P21W, 1156, 1141 used behind red lens
93117208	Canbus 5W	1	4	
93117209	Canbus 21W	1	4	



High Intensity Discharge Lamps

- DOT compliant
- Exceptional visibility
- Lasting performance
- White light

Intensify your driving experience with a bright, long-lasting light that outperforms conventional halogen lamps.

Tungram High Intensity Discharge (HID) lamps produce a quality light that gets noticed by car lovers and novices alike.

From behind the wheel, the HID headlamps deliver better visibility and illumination than standard halogen, creating a better driving experience. And from the road, HID delivers an eye-catching, white-light style that stands out.



High performance light for high performance people.

High Intensity Discharge lamps

SKU	Lamp Type	Lamps/UOS	UOS/Case
93116614	D1R	1	4
93115997	D1S	1	4
93116048	D2R	1	3
93116049	D2S	1	3
93116615	D3R	1	4
93116613	D3S	1	4
93116612	D4R	1	3
93116611	D4S	1	3

A better driving experience is in the details.

Extensive design and testing confirm that Tungram HID lamps are fully interchangeable with those of other major lamp manufacturers and can be operated on all available control units.

Better Visibility

Greater illumination on the road for improved hazard awareness and navigation in poor driving conditions.

Increased Efficiency

A 3,000-hour rating while consuming 20W less power when compared to standard halogen headlamps, which consume 55W.

Improved Durability

Excellent vibration and shock resistance, resulting in significantly greater reliability than standard halogen lamps.

Advanced Optics

A white light that more closely resembles natural daylight.

Tungram HID Discharge

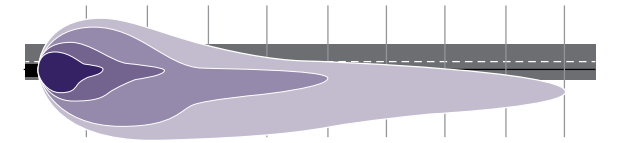

Standard Halogen

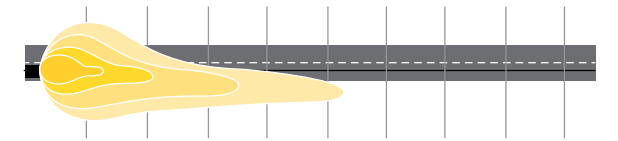

For illustration purposes only



Always replace lamps in pairs

Halogen Headlight Lamps

Lighting your way...

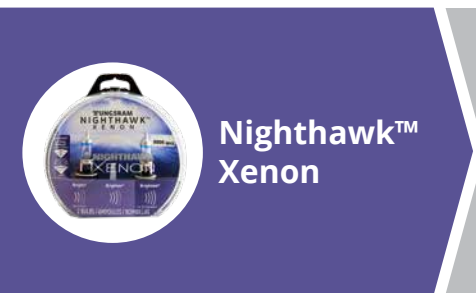

Nighthawk™ Xenon

Nighthawk™ Xenon is the highest performance road legal halogen bulb option available from Tungsram.

Optimized for breakthrough performance

For Brightest Illumination

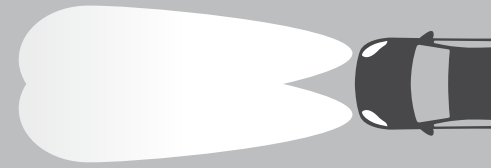

Nighthawk™ Platinum

Nighthawk™ Platinum is the Nighthawk family's next-level upgrade for performance.

Improved illumination performance

For Brighter Illumination



Nighthawk™

Nighthawk™ is a value upgrade to our Standard line for improved brightness and safety.

Special performance for improved visibility

For Bright Illumination



Long Life

Tungsram Long Life lamps offer long-lasting performance from an OEM-quality supplier.

Delivering high-quality light with less need for replacements

For longer driving periods



Standard lamps

Tungsram's Standard line of family replacement lamps deliver dependability and performance from an OEM lamp supplier.

Setting the standard in halogen replacement lamps

Lighting the road for quality and value



NIGHTHAWK™ XENON

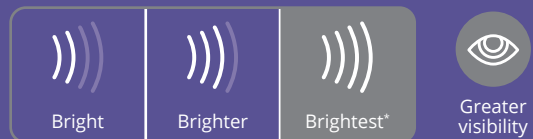

Quality and visibility that go far and wide.

The cutting-edge look of NIGHTHAWK™ XENON headlamps presents the highest performance of NIGHTHAWK™ technology. Tungram NIGHTHAWK™ XENON is a revolutionary solution that propels style and performance similar to HID-caliber lighting at a fraction of the cost. That means no high-cost conversion!



* Compared to a Tungram standard halogen headlamp bulb. Specific light levels vary by bulb type and headlamp assembly.



Exceptional light. Exceptional experience.

NIGHTHAWK™ Xenon			
SKU	Lamp Type	Lamps/UOS	UOS/Case
93116378	H1-55 NHX	2	3
93116379	H4-60/55 NHX	2	3
93116380	H7-55 NHX	2	3
93116385	H11-55 NHX	2	3
93116381	HB2 (9003) NHX	2	3
93116382	HB3 (9005) NHX	2	3
93116383	HB4 (9006) NHX	2	3
93116384	HB5 (9007) NHX	2	3
93116376	H13 (9008) NHX	2	3

With the exception of the H4, all Tungram halogen headlamps above are DOT compliant.

Tungram NIGHTHAWK™ XENON casts a bright, white light for better visibility down the road and around the bend. The silver top gives an attractive appearance, especially in clear reflective headlamps. They operate on standard 12V power with no costly or complex converters to install.

Tungram NIGHTHAWK™ XENON

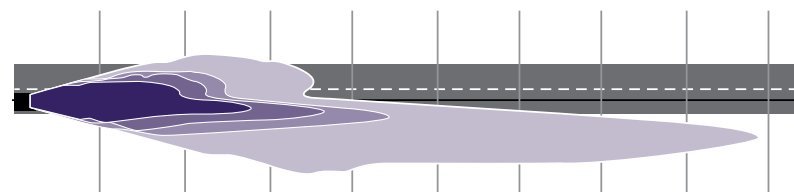

Standard

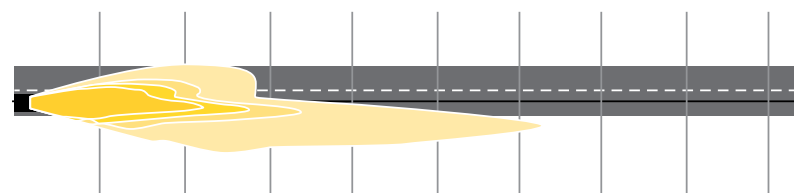

For illustration purposes only



Always replace lamps in pairs

NIGHTHAWK™ PLATINUM

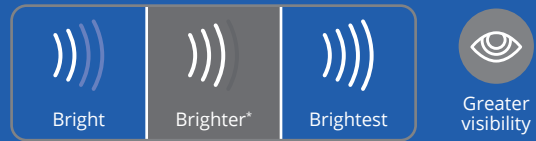

Maximum white light.
Maximum peace of mind.

High-performance lamps for visibility, convenience and style.

Regardless of the nighttime conditions, Tungram NIGHTHAWK™ PLATINUM headlamps give you more visibility to see and react to what's ahead. And their white-light style makes them stand out for other drivers on the road, too.



* Compared to a Tungram standard halogen headlamp bulb. Specific light levels vary by bulb type and headlamp assembly



The right technology at every turn.

NIGHTHAWK™ PLATINUM

SKU	Lamp Type	Lamps/UOS	UOS/Case
93116517	H7-55 NHP	2	3
93116510	H11-55 NHP	2	3
93116512	HB2 (9003) NHP	2	3
93116513	HB1 (9004) NHP	2	3
93116514	HB3 (9005) NHP	2	3
93116515	HB4 (9006) NHP	2	3
93116516	HB5 (9007) NHP	2	3
93116518	H13 (9008) NHP	2	3

With the exception of the H4, all Tungram halogen headlamps above are DOT compliant.

Form meets function when you take night driving to the next level with Tungram NIGHTHAWK™ PLATINUM. The silver top gives an attractive appearance, especially in clear reflective headlamps.

Tungram NIGHTHAWK™ PLATINUM

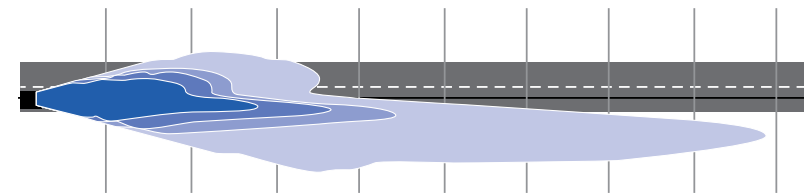

Standard

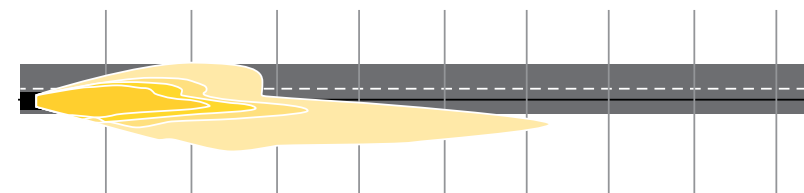

For illustration purposes only



Always replace lamps in pairs

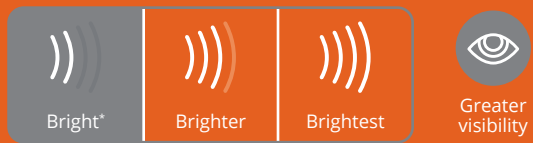

Headlights that provide more light when you need it most.

Whether it's a long straightaway or a route full of twists and turns, drivers want to see more of the road. Tungram NIGHTHAWK™ makes it easier to see what's ahead and what's coming around the bend.



Tungram NIGHTHAWK™

Standard

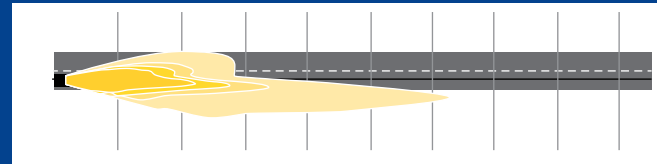
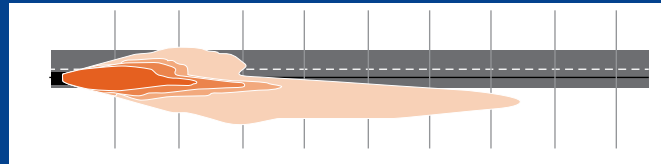

For illustration purposes only

* Compared to a Tungram standard halogen headlamp bulb. Specific light levels vary by bulb type and headlamp assembly.



The right technology at every turn.

NIGHTHAWK™

SKU	Lamp Type	Lamps/ UOS	UOS/ Case
Headlamps (Blister pack)			
93116351	H1-55 NH	1	6
93116503	H1-55 NH	2	3
93116345	H4-60/55 NH	1	6
93116831	H7-55 NH	1	6
93116504	H7-55 NH	2	3
93116511	H11-55 NH	2	3
93116350	HB2 (9003) NH	1	6
93116509	HB2 (9003) NH	2	3
93116349	HB1 (9004) NH	1	6
93116508	HB1 (9004) NH	2	3
93116348	HB3 (9005) NH	1	6
93116507	HB3 (9005) NH	2	3
93116347	HB4 (9006) NH	1	6
93116506	HB4 (9006) NH	2	3
93116346	HB5 (9007) NH	1	6
93116505	HB5 (9007) NH	2	3
93116519	H13 (9008) NH	2	3

Sealed Beams (Boxed)

93115724	H4656 NH	6	1
93115725	H6024 NH	6	1
93115723	H6054 NH	6	1

With the exception of the H4, all Tungram halogen headlamps above are DOT compliant.

NIGHTHAWK™

SKU	Lamp Type	Lamps/ UOS	UOS/ Case
Miniatures (Blister pack)			
93116404	67 NH	2	6
93116409	93 NH	2	6
93116423	161 NH	2	6
93116424	168 NH	2	6
93116425	194 NH	2	6
93116422	194NA NH	2	6
93116401	211-2 NH	2	6
93116428	912 NH	2	6
93116427	921 NH	2	6
93116426	922 NH	2	6
93116410	1073 NH	2	6
93116408	1141 NH	2	6
93116413	1156 NH	2	6
93116411	1157 NH	2	6
93116406	1157NA NH	2	6
93116403	1895 NH	2	6
93116412	2057 NH	2	6
93116407	2057NA NH	2	6
93116405	2357 NH	2	6
93116419	3057 NH	2	6
93116417	3156 NH	2	6
93116420	3157 NH	2	6
93116416	3157NA NH	2	6
93116418	3357/3457 NH	2	6
93116421	7443 NH	2	6
93116402	DE3175 NH	2	6
93116414	P21/5W NH	2	6
93116415	P21W NH	2	6



Always replace lamps in pairs



Long-life lamps that last from here to the horizon.

Tungram long-lasting headlamps and miniatures save time and money in the long run. They're designed to deliver high-quality light with less need for replacements. It's convenient, hassle-free maintenance that leaves more money in your pocket and more time in your day.



Lamps that go the distance.

Long Life			
SKU	Lamp Type	Lamps/ UOS	UOS/ Case
Headlamps (Boxed)			
93116280	HB1 (9004) LL	10	1
93116282	9006XS LL	10	1
24V Headlamps (Boxed)			
93115998	H1-70 24V HDLL	10	1
93116001	H3-70 24V HDLL	10	1
93115999	H4-75/70 24V HDLL	10	1
93116000	H7-70 24V HDLL	10	1
Headlamps (Blister pack)			
93116315	H7-55 LL	6	1
93116317	H11-55 LL	6	1
93116316	HB2 (9003) LL	6	1
93116309	HB1 (9004) LL	6	1
93116311	HB3 (9005) LL	6	1
93116310	9005XS LL	6	1
93116313	HB4 (9006) LL	6	1
93116312	9006XS LL	6	1
93116314	HB5 (9007) LL	6	1
Sealed Beams (Boxed)			
93115714	H5024	6	1
93115712	H5051	6	1
93115715	H5054	6	1
93115713	H5062	6	1

Long Life			
SKU	Lamp Type	Lamps/ UOS	UOS/ Case
Miniatures (Boxed)			
93115888	2232 LL	50	1
93116826	4114 LL	50	1
93116296	4157NA LL	50	1
Miniatures (Blister pack)			
93116387	89 LL	2	6
93116399	194 LL	2	6
93116400	194NA LL	2	6
93116386	1003 LL	2	6
93116388	1156 LL	2	6
93116389	1157 LL	2	6
93116802	1157NA LL	2	6
93116390	2057 LL	2	6
93116803	2057NA LL	2	6
93116392	3057 LL	2	6
93116395	3156 LL	2	6
93116391	3157 LL	2	6
93116394	3157NA LL	2	6
93116393	3357/3457 LL	2	6
93116398	4057 LL	2	6
93116397	4114 LL	2	6
93116377	4157 LL	2	6
93116396	4157NA LL	2	6
93116804	W5W LL	2	6

With the exception of the H4 and 24V lamps, all Tungram halogen headlamps above are DOT compliant.



Always replace lamps in pairs

Standard

Halogen replacement lamps that set the standard.

Value and performance you can depend on mile after mile.

Tungram standard halogen replacement lamps bring innovation to a baseline product to maximize value for the driver. This replacement option delivers dependable performance and excellent light quality.



Shine quality and value on the road.

Standard			
SKU	Lamp Type	Lamps/UOS	UOS/Case
Headlamps (Boxed)			
93116051	H1-55	10	1
93116052	H1-70 24V	10	1
93116053	H3-55	10	1
93116054	H3-70 24V	10	1
93116055	H4-60/55	10	1
93116056	H4-75/70 24V	10	1
93116057	H7-55	10	1
93116050	H11-55	10	1
93115996	HB2 (9003)	10	1
93116281	HB1 (9004)	10	1
93115864	HB3 (9005)	10	1
93115865	HB4 (9006)	10	1
93116361	HB5 (9007)	10	1
93116362	H13 (9008)	10	1
Sealed Beams (Boxed)			
93115717	4405	12	1
93115716	4416	12	1
93115718	4505	12	1
93115719	4509	12	1
93115720	4515	12	1
93115721	4537	12	1
93115722	4880	12	1
93115726	4411-3	12	1
93115728	4537-2	12	1
93115727	H4515	12	1
93115708	H4651	6	1
93115709	H4656	6	1
93115711	H4666/H4668	6	1
93115707	H6024	6	1
93115710	H6054	6	1

Standard			
SKU	Lamp Type	Lamps/UOS	UOS/Case
Fog Lamps (Boxed)			
93116363	862	10	1
93116359	892	10	1
93116360	894	10	1
93116364	898	10	1
Headlamps (Blister pack)			
93116338	H1-55	1	6
93116323	H3-55	1	6
93116324	H3-100	1	6
93116326	H4-60/55	1	6
93116344	H4-60/55 MS	1	6
93116335	H7-55	1	6
93116336	H8	1	6
93116337	H9	1	6
93116341	H11-55	1	6
93116343	H11B	1	6
93116334	HB2 (9003)	1	6
93116498	HB2 (9003)	2	3
93116327	HB1 (9004)	1	6
93116499	HB1 (9004)	2	3
93116332	HB3 (9005)	1	6
93116340	HB4 (9006)	1	6
93116500	HB4 (9006)	2	3
93116333	HB5 (9007)	1	6
93116501	HB5 (9007)	2	3
93116342	H13 (9008)	1	6
93116352	HIR2 (9012)	1	6
Fog Lamps (Blister pack)			
93116318	880	1	6
93116319	881	1	6
93116320	885	1	6
93116325	886	1	6
93116321	889	1	6
93116322	893	1	6
93116329	894	1	6
93116330	896	1	6
93116331	898	1	6
93116328	899	1	6
93116339	H10 (9145)	1	6



Always replace lamps in pairs

Standard

Standard			
SKU	Lamp Type	Lamps/UOS	UOS/Case
Miniatures (Boxed)			
93116828	24	50	1
93116289	37	50	1
93116024	44	50	1
93116025	47	50	1
93116026	53	50	1
93116829	55	50	1
93116028	57	50	1
93116030	67	50	1
93116031	68	50	1
93116290	74	50	1
93115883	88	50	1
93116033	89	50	1
93116045	93	50	1
93116047	97	50	1
93116009	161	50	1
93116010	168	50	1
93116015	193	50	1
93116016	194	50	1
93116017	194NA	50	1
93116018	199	50	1
93115884	210	50	1
93116021	211-2	50	1
93115740	265	50	1
93115741	303	50	1
93115742	304	50	1
93115885	305	50	1
93115886	306	50	1
93115897	307	50	1
93115898	308	50	1
93115743	313	50	1
93115744	316	50	1
93115900	327	50	1
93115730	356	50	1
93115901	382	50	1
93115896	400	50	1
93115887	456	50	1
93115737	464	50	1
93116027	561	50	1
93115729	590	50	1
93115745	623	50	1
93116029	631	50	1
93115752	658	50	1
93116032	755	50	1
93115731	756	50	1
93115746	757	50	1
93116035	904	50	1

Standard			
SKU	Lamp Type	Lamps/UOS	UOS/Case
Miniatures (Boxed)			
93116036	906	50	1
93116037	908	50	1
93116038	909	50	1
93116039	912	50	1
93116040	915	50	1
93116041	918	50	1
93116042	921	50	1
93116043	922	50	1
93116044	927	50	1
93116046	939	50	1
93116292	1003	50	1
93116291	1004	50	1
93116003	1073	50	1
93116307	1076	50	1
93116004	1141	50	1
93116308	1142	50	1
93116005	1156	50	1
93116830	1156NA	50	1
93116006	1157	50	1
93116007	1157NA	50	1
93115889	1196	50	1
93115753	1251	50	1
93115751	1315	50	1
93116008	1445	50	1
93115732	1450 24V	50	1
93115890	1612	50	1
93115891	1665	50	1
93115892	1683	50	1
93115893	1691	50	1
93115894	1692	50	1
93115733	1813	50	1
93116011	1816	50	1
93115747	1818 24V	50	1
93115748	1819	50	1
93115749	1820	50	1
93115734	1822	50	1
93115735	1828	50	1
93115750	1829	50	1
93115736	1835	50	1
93115899	1864	50	1
93115895	1866	50	1
93115738	1873	50	1
93116012	1891	50	1
93116013	1893	50	1
93116014	1895	50	1
93116294	1982SP	50	1

Standard			
SKU	Lamp Type	Lamps/UOS	UOS/Case
Miniatures (Boxed)			
93116019	2057	50	1
93116020	2057NA	50	1
93116295	2059	50	1
93116832	2232	50	1
93116022	2357	50	1
93116023	2357NA	50	1
93116301	3057	50	1
93116302	3057NA	50	1
93116303	3156	50	1
93116299	3157	50	1
93116300	3157NA	50	1
93116304	3357/ 3457	50	1
93116305	3357/3457NA	50	1
93116827	3757NA	50	1
93116298	7440	50	1
93116297	7443	50	1
93116293	DE3175	50	1
93116002	P21/5W	50	1
Miniatures (Blister pack)			
93116480	37	2	6
93116445	53	2	6
93116446	57	2	6
93116448	63	2	6
93116450	67	2	6
93116479	73	2	6
93116478	74	2	6
93116451	89	2	6
93116452	90	2	6
93116465	93	2	6
93116520	93 HI	2	6
93116449	97	2	6
93116488	161	2	6
93116486	168	2	6
93116487	194	2	6
93116485	194NA	2	6
93116439	211-2	2	6
93116441	212-2	2	6
93116438	561	2	6
93116440	562	2	6
93116453	631	2	6
93116492	904	2	6
93116491	906	2	6
93116490	912	2	6
93116493	916	2	6
93116495	918	2	6

Standard			
SKU	Lamp Type	Lamps/UOS	UOS/Case
Miniatures (Blister pack)			
93116497	921	2	6
93116494	922	2	6
93116496	923	2	6
93116429	1003	2	6
93116430	1004	2	6
93116469	1073	2	6
93116463	1141	2	6
93116462	1156	2	6
93116464	1156NA	2	6
93116456	1157	2	6
93116460	1157NA	2	6
93116432	1445	2	6
93116435	1816	2	6
93116433	1891	2	6
93116434	1893	2	6
93116447	1895	2	6
93116457	2057	2	6
93116461	2057NA	2	6
93116458	2357	2	6
93116459	2357NA	2	6
93116436	3057	2	6
93116472	3057NA	2	6
93116477	3155	2	6
93116474	3156	2	6
93116471	3157	2	6
93116473	3157NA	2	6
93116475	3357/3457	2	6
93116476	3357/3457NA	2	6
93116481	3757NA	2	6
93116483	7440	2	6
93116484	7443	2	6
93116502	7443NA	2	6
93116442	C5W	2	6
93116444	DE3021	2	6
93116431	DE3022	2	6
93116437	DE3175	2	6
93116443	DE7576	2	6
93116468	P21/4W	2	6
93116466	P21/5W	2	6
93116467	P21W	2	6
93116470	PY21W	2	6
93116454	R5W	2	6
93116455	R10W	2	6
93116482	T4W	2	6
93116489	W5W	2	6

GE/Tungsrām cross reference

Lamp Type	Pack Type	GE			TUNGSRAM		
		SKU	UPC	GTIN	SKU2	UPC2	GTIN2
24	Boxed	17853	43168962841	00043168178532	93116828	5994100055716	25994100055710
37	BP	78153	43168264808	00043168781534	93116480	5994100050841	25994100050845
37	Boxed	27213	43168272131	10043168272138	93116289	5994100048930	25994100048934
44	Boxed	93708	43168937085	10043168937082	93116024	5994100046790	25994100046794
47	Boxed	93709	43168937092	10043168937099	93116025	5994100046806	25994100046800
53	BP	76686	43168962094	00043168766869	93116445	5994100050490	25994100050494
53	Boxed	93711	43168937115	10043168937112	93116026	5994100046813	25994100046817
55	Boxed	25576	43168963008	00043168255769	93116829	5994100055723	25994100055727
57	BP	76710	43168232180	00043168767101	93116446	5994100050506	25994100050500
57	Boxed	93715	43168937153	10043168937150	93116028	5994100046837	25994100046831
63	BP	76714	43168961011	00043168767149	93116448	5994100050520	25994100050524
67	BP	76964	43168962100	00043168769648	93116450	5994100050544	25994100050548
67	Boxed	93723	43168937238	10043168937235	93116030	5994100046851	25994100046855
67 NH	BP	73480	43168718950	00043168734806	93116404	5994100050087	25994100050081
68	Boxed	93724	43168937245	10043168937242	93116031	5994100046868	25994100046862
73	BP	78137	43168230155	00043168781374	93116479	5994100050834	25994100050838
73	Boxed	14216	43168142168	10043168142165	93116283	5994100049692	25994100049696
74	BP	78130	43168210294	00043168781305	93116478	5994100050827	25994100050821
74	Boxed	27242	43168272421	10043168272428	93116290	5994100048947	25994100048941
85	Boxed	40969	43168409698	10043168409695	93115739	5994100045267	25994100045261
88	Boxed	25772	43168963756	00043168257725	93115883	5994100045601	25994100045605
89	BP	76965	43168961028	00043168769655	93116451	5994100050551	25994100050555
89	Boxed	93735	43168937351	10043168937358	93116033	5994100046882	25994100046886
89 LL	BP	72975	43168477970	00043168729758	93116387	5994100049913	25994100049917
90	BP	77378	43168961035	00043168773782	93116452	5994100050568	25994100050562
90	Boxed	93737	43168937375	10043168937372	93116034	5994100046899	25994100046893
93	BP	77857	43168232173	00043168778572	93116465	5994100050698	25994100050692
93	Boxed	93779	43168937795	10043168937792	93116045	5994100047001	25994100047005
93 HI	BP	94854	43168948548	10043168948545	93116520	5994100051244	25994100051248

Lamp Type	Pack Type	GE			TUNGSRAM		
		SKU	UPC	GTIN	SKU2	UPC2	GTIN2
93 NH	BP	73576	43168719049	00043168735766	93116409	5994100050131	25994100050135
94	Boxed	98456	43168984560	10043168984567	93116306	5994100049104	25994100049108
97	BP	76799	43168961042	00043168767996	93116449	5994100050537	25994100050531
97	Boxed	94415	43168944151	10043168944158	93116047	5994100047025	25994100047029
161	BP	78562	43168230162	00043168785624	93116488	5994100050926	25994100050920
161	Boxed	93516	43168935166	10043168935163	93116009	5994100046646	25994100046640
161 NH	BP	73764	43168719025	00043168737647	93116423	5994100050278	25994100050272
168	BP	78386	43168961165	00043168783866	93116486	5994100050902	25994100050906
168	Boxed	93526	43168935265	10043168935262	93116010	5994100046653	25994100046657
168 NH	BP	73771	43168892391	00043168737715	93116424	5994100050285	25994100050289
193	Boxed	93559	43168935593	10043168935590	93116015	5994100046707	25994100046701
194	BP	78481	43168961059	00043168784818	93116487	5994100050919	25994100050913
194	Boxed	93580	43168935807	10043168935804	93116016	5994100046714	25994100046718
194 LL	BP	73345	43168258326	00043168733458	93116399	5994100050032	25994100050036
194 NH	BP	73772	43168892407	00043168737722	93116425	5994100050292	25994100050296
194NA	BP	78347	43168960441	00043168783477	93116485	5994100050896	25994100050890
194NA	Boxed	93583	43168935838	10043168935835	93116017	5994100046721	25994100046725
194NA LL	BP	73362	43168477949	00043168733625	93116400	5994100050049	25994100050043
194NA NH	BP	73763	43168718943	00043168737630	93116422	5994100050261	25994100050265
199	Boxed	93586	43168935869	10043168935866	93116018	5994100046738	25994100046732
210	Boxed	25988	43168259880	10043168259887	93115884	5994100045618	25994100045612
211-2	BP	76499	43168961066	00043168764995	93116439	5994100050438	25994100050432
211-2	Boxed	93650	43168936507	10043168936504	93116021	5994100046769	25994100046763
211-2 NH	BP	73368	43168719001	00043168733687	93116401	5994100050056	25994100050050
212-2	BP	76506	43168232203	00043168765060	93116441	5994100050452	25994100050456
265	Boxed	44719	43168447195	10043168447192	93115740	5994100045274	25994100045278
303	Boxed	81641	43168816410	10043168816417	93115741	5994100045281	25994100045285
304	Boxed	81643	43168816434	10043168816431	93115742	5994100045298	25994100045292
305	Boxed	26143	43168963688	00043168261432	93115885	5994100045625	25994100045629

GE/Tungsrām cross reference

Lamp Type	Pack Type	GE			TUNGSRAM		
		SKU	UPC	GTIN	SKU2	UPC2	GTIN2
306	Boxed	26152	43168261524	10043168261521	93115886	5994100045632	25994100045636
307	Boxed	81644	43168816441	10043168816448	93115897	5994100045748	25994100045742
308	Boxed	81645	43168816458	10043168816455	93115898	5994100045755	25994100045759
313	Boxed	81649	43168816496	10043168816493	93115743	5994100045304	25994100045308
316	Boxed	81652	43168816526	10043168816523	93115744	5994100045311	25994100045315
327	Boxed	28519	43168285193	10043168285190	93115900	5994100045779	25994100045773
356	Boxed	26255	43168963428	00043168262552	93115730	5994100045175	25994100045179
382	Boxed	28657	43168286572	10043168286579	93115901	5994100045786	25994100045780
400	Boxed	38918	43168389181	10043168389188	93115896	5994100045731	25994100045735
456	Boxed	26441	43168963596	00043168264419	93115887	5994100045649	25994100045643
464	Boxed	39645	43168396455	10043168396452	93115737	5994100045243	25994100045247
561	BP	76485	43168961578	00043168764858	93116438	5994100050421	25994100050425
561	Boxed	93713	43168937139	10043168937136	93116027	5994100046820	25994100046824
562	BP	76505	43168230193	00043168765053	93116440	5994100050445	25994100050449
590	Boxed	18442	43168184427	10043168184424	93115729	5994100045168	25994100045162
623	Boxed	81653	43168816533	10043168816530	93115745	5994100045328	25994100045322
631	BP	77383	43168230230	00043168773836	93116453	5994100050575	25994100050579
631	Boxed	93721	43168937214	10043168937211	93116029	5994100046844	25994100046848
658	Boxed	81670	43168816700	10043168816707	93115752	5994100045397	25994100045391
755	Boxed	93726	43168937269	10043168937266	93116032	5994100046875	25994100046879
756	Boxed	26593	43168963695	00043168265935	93115731	5994100045182	25994100045186
757	Boxed	81655	43168816557	10043168816554	93115746	5994100045335	25994100045339
862	Boxed	40848	43168408486	10043168408483	93116363	5994100051473	25994100051477
880	BP	78706	43168960366	00043168787062	93116318	5994100049227	25994100049221
881	BP	78717	43168960373	00043168787178	93116319	5994100049234	25994100049238
885	BP	78733	43168960380	00043168787338	93116320	5994100049241	25994100049245
886	BP	78801	43168146890	00043168788014	93116325	5994100049296	25994100049290
889	BP	78735	43168960397	00043168787352	93116321	5994100049258	25994100049252
892	Boxed	16481	43168963589	00043168164818	93116359	5994100051435	25994100051439

Lamp Type	Pack Type	GE			TUNGSRAM		
		SKU	UPC	GTIN	SKU2	UPC2	GTIN2
893	BP	78741	43168960540	00043168787413	93116322	5994100049265	25994100049269
894	BP	78992	43168221122	00043168789929	93116329	5994100049333	25994100049337
894	Boxed	20238	43168202381	20043168202385	93116360	5994100051442	25994100051446
896	BP	78993	43168221139	00043168789936	93116330	5994100049340	25994100049344
898	BP	78995	43168980937	00043168789950	93116331	5994100049357	25994100049351
898	Boxed	96497	43168964975	30043168964976	93116364	5994100051480	25994100051484
899	BP	78991	43168221115	00043168789912	93116328	5994100049326	25994100049320
904	BP	78585	43168230247	00043168785853	93116492	5994100050964	25994100050968
904	Boxed	93740	43168937405	10043168937402	93116035	5994100046905	25994100046909
906	BP	78580	43168960489	00043168785808	93116491	5994100050957	25994100050951
906	Boxed	93747	43168937474	10043168937471	93116036	5994100046912	25994100046916
908	Boxed	93749	43168937498	10043168937495	93116037	5994100046929	25994100046923
909	Boxed	93751	43168937511	10043168937518	93116038	5994100046936	25994100046930
912	BP	78569	43168961585	00043168785693	93116490	5994100050940	25994100050944
912	Boxed	93752	43168937528	10043168937525	93116039	5994100046943	25994100046947
912 NH	BP	73857	43168892421	00043168738576	93116428	5994100050322	25994100050326
915	Boxed	93753	43168937535	10043168937532	93116040	5994100046950	25994100046954
916	BP	78586	43168230254	00043168785860	93116493	5994100050971	25994100050975
918	BP	78594	43168401791	00043168785945	93116495	5994100050995	25994100050999
918	Boxed	93754	43168937542	10043168937549	93116041	5994100046967	25994100046961
921	BP	78600	43168961592	00043168786003	93116497	5994100051015	25994100051019
921	Boxed	93755	43168937559	10043168937556	93116042	5994100046974	25994100046978
921 NH	BP	73847	43168892384	00043168738477	93116427	5994100050315	25994100050319
922	BP	78592	43168230278	00043168785921	93116494	5994100050988	25994100050982
922	Boxed	93757	43168937573	10043168937570	93116043	5994100046981	25994100046985
922 NH	BP	73846	43168719032	00043168738460	93116426	5994100050308	25994100050302
923	BP	78596	43168401807	00043168785969	93116496	5994100051008	25994100051002
927	Boxed	93758	43168937580	10043168937587	93116044	5994100046998	25994100046992
939	Boxed	93785	43168937856	10043168937853	93116046	5994100047018	25994100047012

GE/Tungsrām cross reference

Lamp Type	Pack Type	GE			TUNGSRAM		
		SKU	UPC	GTIN	SKU2	UPC2	GTIN2
939	Bulk	15285	43168152853	00043168152853	93115255	5994100038481	25994100038485
1003	BP	73858	43168961073	00043168738583	93116429	5994100050339	25994100050333
1003	Boxed	27477	43168274777	10043168274774	93116292	5994100048961	25994100048965
1003 LL	BP	72974	43168478007	00043168729741	93116386	5994100049906	25994100049900
1004	BP	73861	43168961080	00043168738613	93116430	5994100050346	25994100050340
1004	Boxed	27417	43168274173	10043168274170	93116291	5994100048954	25994100048958
1073	BP	77871	43168401340	00043168778718	93116469	5994100050735	25994100050739
1073	Boxed	93453	43168934534	10043168934531	93116003	5994100046585	25994100046589
1073 NH	BP	73584	43168719056	00043168735841	93116410	5994100050148	25994100050142
1076	Boxed	98458	43168984584	10043168984581	93116307	5994100049111	25994100049115
1141	BP	77745	43168961097	00043168777452	93116463	5994100050674	25994100050678
1141	Boxed	93456	43168934565	10043168934562	93116004	5994100046592	25994100046596
1141 NH	BP	73575	43168718974	00043168735759	93116408	5994100050124	25994100050128
1142	Boxed	98461	43168984614	10043168984611	93116308	5994100049128	25994100049122
1156	BP	77614	43168961110	00043168776141	93116462	5994100050667	25994100050661
1156	Boxed	93472	43168934725	10043168934722	93116005	5994100046608	25994100046602
1156 LL	BP	72976	43168233347	00043168729765	93116388	5994100049920	25994100049924
1156 NH	BP	73590	43168892414	00043168735902	93116413	5994100050179	25994100050173
1156NA	BP	77854	43168210287	00043168778541	93116464	5994100050681	25994100050685
1156NA	Boxed	27153	43168271530	10043168271537	93116830	5994100053156	25994100053150
1157	BP	77422	43168961127	00043168774222	93116456	5994100050605	25994100050609
1157	Boxed	93493	43168934930	10043168934937	93116006	5994100046615	25994100046619
1157 LL	BP	72997	43168233378	00043168729970	93116389	5994100049937	25994100049931
1157 NH	BP	73586	43168892360	00043168735865	93116411	5994100050155	25994100050159
1157NA	BP	77474	43168961134	00043168774741	93116460	5994100050643	25994100050647
1157NA	Boxed	93502	43168935029	10043168935026	93116007	5994100046622	25994100046626
1157NA LL	BP	73002	43168477987	00043168730020	93116802	5994100052890	25994100052894
1157NA NH	BP	73492	43168718912	00043168734929	93116406	5994100050100	25994100050104
1196	Boxed	27026	43168270267	10043168270264	93115889	5994100045663	25994100045667

Lamp Type	Pack Type	GE			TUNGSRAM		
		SKU	UPC	GTIN	SKU2	UPC2	GTIN2
1251	Boxed	81679	43168816793	10043168816790	93115753	5994100045403	25994100045407
1315	Boxed	81667	43168816670	10043168816677	93115751	5994100045380	25994100045384
1445	BP	73989	43168961141	00043168739894	93116432	5994100050360	25994100050364
1445	Boxed	93514	43168935142	10043168935149	93116008	5994100046639	25994100046633
1450	Boxed	27263	43168963725	00043168272636	93115732	5994100045199	25994100045193
1612	Boxed	27461	43168274616	10043168274613	93115890	5994100045670	25994100045674
1665	Boxed	27532	43168275323	10043168275320	93115891	5994100045687	25994100045681
1683	Boxed	27557	43168275576	10043168275573	93115892	5994100045694	25994100045698
1691	Boxed	27566	43168963923	00043168275668	93115893	5994100045700	25994100045704
1692	Boxed	27571	43168275712	10043168275719	93115894	5994100045717	25994100045711
1813	Boxed	27667	43168276672	10043168276679	93115733	5994100045205	25994100045209
1816	BP	74087	43168960496	00043168740876	93116435	5994100050391	25994100050395
1816	Boxed	93529	43168935296	10043168935293	93116011	5994100046660	25994100046664
1818	Boxed	81659	43168816595	10043168816592	93115747	5994100045342	25994100045346
1819	Boxed	81660	43168816601	10043168816608	93115748	5994100045359	25994100045353
1820	Boxed	81663	43168816632	10043168816639	93115749	5994100045366	25994100045360
1822	Boxed	27749	43168963916	00043168277495	93115734	5994100045212	25994100045216
1828	Boxed	27772	43168964005	00043168277723	93115735	5994100045229	25994100045223
1829	Boxed	81664	43168816649	10043168816646	93115750	5994100045373	25994100045377
1835	Boxed	27804	43168278041	10043168278048	93115736	5994100045236	25994100045230
1864	Boxed	81665	43168816656	10043168816653	93115899	5994100045762	25994100045766
1866	Boxed	27868	43168278683	10043168278680	93115895	5994100045724	25994100045728
1873	Boxed	40383	43168963527	00043168403832	93115738	5994100045250	25994100045254
1891	BP	74006	43168962124	00043168740067	93116433	5994100050377	25994100050371
1891	Boxed	93536	43168935364	10043168935361	93116012	5994100046677	25994100046671
1893	BP	74007	43168962131	00043168740074	93116434	5994100050384	25994100050388
1893	Boxed	93538	43168935388	10043168935385	93116013	5994100046684	25994100046688
1895	BP	76711	43168961158	00043168767118	93116447	5994100050513	25994100050517
1895	Boxed	93558	43168935586	10043168935583	93116014	5994100046691	25994100046695

GE/Tungsrām cross reference

Lamp Type	Pack Type	GE			TUNGSRAM		
		SKU	UPC	GTIN	SKU2	UPC2	GTIN2
1895 NH	BP	73401	43168718967	00043168734011	93116403	5994100050070	25994100050074
1982SP	Boxed	27853	43168278539	10043168278536	93116294	5994100048985	25994100048989
2057	BP	77427	43168961493	00043168774277	93116457	5994100050612	25994100050616
2057	Boxed	93589	43168935890	10043168935897	93116019	5994100046745	25994100046749
2057 LL	BP	73000	43168233392	00043168730006	93116390	5994100049944	25994100049948
2057 NH	BP	73589	43168892377	00043168735896	93116412	5994100050162	25994100050166
2057NA	BP	77475	43168961509	00043168774758	93116461	5994100050650	25994100050654
2057NA	Boxed	93649	43168936491	10043168936498	93116020	5994100046752	25994100046756
2057NA LL	BP	73004	43168477994	00043168730044	93116803	5994100052906	25994100052900
2057NA NH	BP	73496	43168718929	00043168734967	93116407	5994100050117	25994100050111
2059	Boxed	33119	43168331197	10043168331194	93116295	5994100048992	25994100048996
2232	Boxed	98516	43168985161	10043168985168	93116832	5994100053163	25994100053167
2232 LL	Boxed	26702	43168267021	10043168267028	93115888	5994100045656	25994100045650
2357	BP	77464	43168962148	00043168774642	93116458	5994100050629	25994100050623
2357	Boxed	93667	43168936675	10043168936672	93116022	5994100046776	25994100046770
2357 NH	BP	73481	43168718905	00043168734813	93116405	5994100050094	25994100050098
2357NA	BP	77473	43168962155	00043168774734	93116459	5994100050636	25994100050630
2357NA	Boxed	93699	43168936996	10043168936993	93116023	5994100046783	25994100046787
3057	BP	74179	43168962070	00043168741798	93116436	5994100050407	25994100050401
3057	Boxed	98434	43168984348	10043168984345	93116301	5994100049050	25994100049054
3057 LL	BP	73246	43168263788	00043168732468	93116392	5994100049968	25994100049962
3057 NH	BP	73643	43168892438	00043168736435	93116419	5994100050230	25994100050234
3057NA	BP	77877	43168962087	00043168778770	93116472	5994100050766	25994100050760
3057NA	Boxed	98435	43168984355	10043168984352	93116302	5994100049067	25994100049061
3155	BP	77883	43168230285	00043168778831	93116477	5994100050810	25994100050814
3156	BP	77879	43168960502	00043168778794	93116474	5994100050780	25994100050784
3156	Boxed	98446	43168984461	10043168984468	93116303	5994100049074	25994100049078
3156 LL	BP	73339	43168275651	00043168733397	93116395	5994100049999	25994100049993
3156 NH	BP	73596	43168718981	00043168735964	93116417	5994100050216	25994100050210

Lamp Type	Pack Type	GE			TUNGSRAM		
		SKU	UPC	GTIN	SKU2	UPC2	GTIN2
3157	BP	77876	43168962056	00043168778763	93116471	5994100050759	25994100050753
3157	Boxed	98432	43168984324	10043168984321	93116299	5994100049036	25994100049030
3157 LL	BP	73245	43168263771	00043168732451	93116391	5994100049951	25994100049955
3157 NH	BP	73644	43168892445	00043168736442	93116420	5994100050247	25994100050241
3157NA	BP	77878	43168962063	00043168778787	93116473	5994100050773	25994100050777
3157NA	Boxed	98433	43168984331	10043168984338	93116300	5994100049043	25994100049047
3157NA LL	BP	73272	43168263801	00043168732727	93116394	5994100049982	25994100049986
3157NA NH	BP	73595	43168718936	00043168735957	93116416	5994100050209	25994100050203
3357/3457	BP	77880	43168143875	00043168778800	93116475	5994100050797	25994100050791
3357/3457	Boxed	98448	43168984485	10043168984482	93116304	5994100049081	25994100049085
3357/3457 LL	BP	73247	43168263795	00043168732475	93116393	5994100049975	25994100049979
3357/3457 NH	BP	73640	43168719018	00043168736404	93116418	5994100050223	25994100050227
3357/3457NA	BP	77881	43168143882	00043168778817	93116476	5994100050803	25994100050807
3357/3457NA	Boxed	98450	43168984508	10043168984505	93116305	5994100049098	25994100049092
3757NA	BP	78205	43168679084	00043168782050	93116481	5994100050858	25994100050852
3757NA	Boxed	14083	43168140836	10043168140833	93116827	5994100053149	25994100053143
4057 LL	BP	73342	43168759342	00043168733427	93116398	5994100050025	25994100050029
4114 LL	BP	73341	43168759335	00043168733410	93116397	5994100050018	25994100050012
4114 LL	Boxed	14082	43168140829	10043168140826	93116826	5994100053132	25994100053136
4157 LL	BP	62852	43168156578	00043168628525	93116377	5994100049814	25994100049818
4157NA LL	BP	73340	43168474580	00043168733403	93116396	5994100050001	25994100050005
4157NA LL	Boxed	33297	43168332972	10043168332979	93116296	5994100049005	25994100049009
7440	BP	78207	43168262002	00043168782074	93116483	5994100050872	25994100050876
7440	Boxed	98376	43168983761	10043168983768	93116298	5994100049029	25994100049023
7443	BP	78208	43168262019	00043168782081	93116484	5994100050889	25994100050883
7443	Boxed	98349	43168983495	10043168983492	93116297	5994100049012	25994100049016
7443 NH	BP	73739	43168892483	00043168737395	93116421	5994100050254	25994100050258
7443NA	BP	79488	43168952156	00043168794886	93116502	5994100051060	25994100051064
Canbus 5W	Boxed				93117208	5994100056805	25994100056809

GE/Tungsrām cross reference

Lamp Type	Pack Type	GE			TUNGSRAM		
		SKU	UPC	GTIN	SKU2	UPC2	GTIN2
Canbus 21W	Boxed				93117209	5994100056812	25994100056816
Canbus 55W	Boxed				93117210	5994100056829	25994100056823
C5W	BP	76507	43168233125	00043168765077	93116442	5994100050469	25994100050463
D1R	Boxed	31297	43168312974	10043168312971	93116614	5994100051916	25994100051910
D1S	Boxed	78734	43168787345	30043168787346	93115997	5994100046523	25994100046527
D2R	Boxed	94416	43168944168	30043168944169	93116048	5994100047032	25994100047036
D2S	Boxed	94419	43168944199	30043168944190	93116049	5994100047049	25994100047043
D3R	Boxed	31298	43168312981	10043168312988	93116615	5994100051923	25994100051927
D3S	Boxed	13731	43168137317	30043168137318	93116613	5994100051701	25994100051705
D4R	Boxed	13712	43168137126	30043168137127	93116612	5994100051695	25994100051699
D4S	Boxed	13652	43168136525	30043168136526	93116611	5994100051688	25994100051682
DE3021	BP	76668	43168253239	00043168766685	93116444	5994100050483	25994100050487
DE3022	BP	73870	43168961523	00043168738705	93116431	5994100050353	25994100050357
DE3175	Boxed	27770	43168277709	10043168277706	93116293	5994100048978	25994100048972
DE3175	BP	76467	43168961530	00043168764674	93116437	5994100050414	25994100050418
DE3175 NH	BP	73371	43168892452	00043168733717	93116402	5994100050063	25994100050067
DE7576	BP	76667	43168233248	00043168766678	93116443	5994100050476	25994100050470
H1-55	BP	79059	43168403368	00043168790598	93116338	5994100049425	25994100049429
H1-55	Boxed	94830	43168948302	10043168948309	93116051	5994100047063	25994100047067
H1-55 NH	BP	90688	43168251594	00043168906883	93116351	5994100049555	25994100049559
H1-55 NH	BP	90325	43168250924	00043168903257	93116503	5994100051077	25994100051071
H1-55 NHX	PB	69857	43168698573	10043168698570	93116378	5994100049821	25994100049825
H1-70 24V	Boxed	94833	43168948333	10043168948330	93116052	5994100047070	25994100047074
H1-70 24V HDLL	Boxed	83491	43168834919	10043168834916	93115998	5994100046530	25994100046534
H3-35	BP	78754	43168962179	00043168787543	93116323	5994100049272	25994100049276
H3-55	Boxed	94840	43168948401	10043168948408	93116053	5994100047087	25994100047081
H3-55	Bulk	23442	43168234429	10043168234426	93115263	5994100037972	25994100037976
H3-70 24V	Boxed	94841	43168948418	10043168948415	93116054	5994100047094	25994100047098
H3-70 24V HDLL	Boxed	83497	43168834971	10043168834978	93116001	5994100046561	25994100046565

Lamp Type	Pack Type	GE			TUNGSRAM		
		SKU	UPC	GTIN	SKU2	UPC2	GTIN2
H3-100	BP	78800	43168962186	00043168788007	93116324	5994100049289	25994100049283
H4-60/55	BP	78819	43168962193	00043168788199	93116326	5994100049302	25994100049306
H4-60/55	Boxed	94846	43168948463	10043168948460	93116055	5994100047100	25994100047104
H4-60/55 NH	BP	89199	43168250948	00043168891998	93116345	5994100049494	25994100049498
H4-60/55 NHX	PB	69858	43168698580	10043168698587	93116379	5994100049838	25994100049832
H4-60/55 MS	BP	79272	43168892568	00043168792721	93116344	5994100049487	25994100049481
H4-75/70 24V	Boxed	94848	43168948487	10043168948484	93116056	5994100047117	25994100047111
H4-75/70 24V HDLL	Boxed	83493	43168834933	10043168834930	93115999	5994100046547	25994100046541
H7-55	BP	79018	43168263740	00043168790185	93116335	5994100049395	25994100049399
H7-55	Boxed	94852	43168948524	10043168948521	93116057	5994100047124	25994100047128
H7-55 LL	BP	78679	43168786409	00043168786799	93116315	5994100049197	25994100049191
H7-55 NH	BP	90768	43168251600	00043168907682	93116831	5994100053170	25994100053174
H7-55 NH	BP	90327	43168250955	00043168903271	93116504	5994100051084	25994100051088
H7-55 NHP	BP	90588	43168758215	00043168905886	93116517	5994100051213	25994100051217
H7-55 NHX	PB	69860	43168698603	10043168698600	93116380	5994100049845	25994100049849
H7-70 24V HDLL	Boxed	83495	43168834957	10043168834954	93116000	5994100046554	25994100046558
H8	BP	79031	43168290470	00043168790314	93116336	5994100049401	25994100049405
H9	BP	79058	43168290494	00043168790581	93116337	5994100049418	25994100049412
H11-55	BP	79180	43168237628	00043168791809	93116341	5994100049456	25994100049450
H11-55	Boxed	94420	43168944205	10043168944202	93116050	5994100047056	25994100047050
H11-55 LL	BP	78704	43168892551	00043168787048	93116317	5994100049210	25994100049214
H11-55 NH	BP	90390	43168679015	00043168903905	93116511	5994100051152	25994100051156
H11-55 NHP	BP	90362	43168622677	00043168903622	93116510	5994100051145	25994100051149
H11-55 NHX	PB	69865	43168698658	10043168698655	93116385	5994100049890	25994100049894
H11B	BP	79271	43168691420	00043168792714	93116343	5994100049470	25994100049474
HB2 (9003)	BP	79005	43168982443	00043168790055	93116334	5994100049388	25994100049382
HB2 (9003)	BP	79274	43168722520	00043168792745	93116498	5994100051022	25994100051026
HB2 (9003)	Boxed	22389	43168982429	00043168223898	93115996	5994100046516	25994100046510
HB2 (9003) LL	BP	78685	43168789356	00043168786850	93116316	5994100049203	25994100049207

GE/Tungsrām cross reference

Lamp Type	Pack Type	GE			TUNGSRAM		
		SKU	UPC	GTIN	SKU2	UPC2	GTIN2
HB2 (9003) NH	BP	90686	43168251501	00043168906869	93116350	5994100049548	25994100049542
HB2 (9003) NH	BP	90359	43168251075	00043168903592	93116509	5994100051138	25994100051132
HB2 (9003) NHP	BP	90396	43168758147	00043168903967	93116512	5994100051169	25994100051163
HB2 (9003) NHX	PB	69861	43168698610	10043168698617	93116381	5994100049852	25994100049856
HB1 (9004)	BP	78845	43168962025	00043168788458	93116327	5994100049319	25994100049313
HB1 (9004)	BP	79282	43168146043	00043168792820	93116499	5994100051039	25994100051033
HB1 (9004)	Boxed	13382	43168133821	30043168133822	93116281	5994100049678	25994100049672
HB1 (9004) LL	BP	78642	43168139939	00043168786423	93116309	5994100049135	25994100049139
HB1 (9004) LL	Boxed	11249	43168112499	30043168112490	93116280	5994100049661	25994100049665
HB1 (9004) NH	BP	90671	43168251495	00043168906715	93116349	5994100049531	25994100049535
HB1 (9004) NH	BP	90356	43168251068	00043168903561	93116508	5994100051121	25994100051125
HB1 (9004) NHP	BP	90497	43168758154	00043168904971	93116513	5994100051176	25994100051170
HB3 (9005)	BP	78997	43168962032	00043168789974	93116332	5994100049364	25994100049368
HB3 (9005)	Boxed	13384	43168133845	30043168133846	93115864	5994100045892	25994100045896
HB3 (9005) LL	BP	78658	43168613354	00043168786584	93116311	5994100049159	25994100049153
HB3 (9005) NH	BP	90666	43168251488	00043168906661	93116348	5994100049524	25994100049528
HB3 (9005) NH	BP	90355	43168251051	00043168903554	93116507	5994100051114	25994100051118
HB3 (9005) NHP	BP	90500	43168758161	00043168905008	93116514	5994100051183	25994100051187
HB3 (9005) NHX	PB	69862	43168698627	10043168698624	93116382	5994100049869	25994100049863
9005XS LL	BP	78645	43168458665	00043168786454	93116310	5994100049142	25994100049146
HB4 (9006)	BP	79162	43168962049	00043168791625	93116340	5994100049449	25994100049443
HB4 (9006)	BP	79291	43168251358	00043168792912	93116500	5994100051046	25994100051040
HB4 (9006)	Boxed	13397	43168133975	30043168133976	93115865	5994100045908	25994100045902
HB4 (9006) LL	BP	78676	43168613361	00043168786768	93116313	5994100049173	25994100049177
HB4 (9006) NH	BP	90598	43168251471	00043168905985	93116347	5994100049517	25994100049511
HB4 (9006) NH	BP	90354	43168251044	00043168903547	93116506	5994100051107	25994100051101
HB4 (9006) NHP	BP	90534	43168758178	00043168905343	93116515	5994100051190	25994100051194
HB4 (9006) NHX	PB	69863	43168698634	10043168698631	93116383	5994100049876	25994100049870
9006XS LL	BP	78675	43168458689	00043168786751	93116312	5994100049166	25994100049160

Lamp Type	Pack Type	GE			TUNGSRAM		
		SKU	UPC	GTIN	SKU2	UPC2	GTIN2
9006XS LL	Boxed	96481	43168964814	30043168964815	93116282	5994100049685	25994100049689
HB5 (9007)	BP	78998	43168982436	00043168789981	93116333	5994100049371	25994100049375
HB5 (9007)	BP	79308	43168251365	00043168793087	93116501	5994100051053	25994100051057
HB5 (9007)	Boxed	20551	43168960274	00043168205511	93116361	5994100051459	25994100051453
HB5 (9007) LL	BP	78678	43168786393	00043168786782	93116314	5994100049180	25994100049184
HB5 (9007) NH	BP	89533	43168251464	00043168895330	93116346	5994100049500	25994100049504
HB5 (9007) NH	BP	90350	43168251037	00043168903509	93116505	5994100051091	25994100051095
HB5 (9007) NHP	BP	90573	43168758185	00043168905732	93116516	5994100051206	25994100051200
HB5 (9007) NHX	PB	69864	43168698641	10043168698648	93116384	5994100049883	25994100049887
H13 (9008)	BP	79181	43168713429	00043168791816	93116342	5994100049463	25994100049467
H13 (9008)	Boxed	38888	43168388887	30043168388888	93116362	5994100051466	25994100051460
H13 (9008) NH	BP	93014	43168786539	00043168930147	93116519	5994100051237	25994100051231
H13 (9008) NHP	BP	93012	43168624305	00043168930123	93116518	5994100051220	25994100051224
H13 (9008) NHX	PB	22785	43168227858	10043168227855	93116376	5994100048909	25994100048903
HIR2 (9012)	BP	93013	43168964845	00043168930130	93116352	5994100049562	25994100049566
H10 (9145)	BP	79079	43168408431	00043168790796	93116339	5994100049432	25994100049436
LED H7	PB				93116081	5994100044475	25994100044479
LED H7 FAN	PB				93116082	5994100044482	5994100044486
LED H8/H11	PB				93116083	5994100044499	5994100044493
LED H8/H11 FAN	PB				93116084	5994100044505	5994100044509
LED 9006	PB				93116085	5994100047216	5994100047210
LED 9006 FAN	PB				93116086	5994100047223	5994100047227
LED 168, 194	BP				93117370	5994100055778	25994100055772
LED 211-2, 212-2	BP				93117373	5994100055808	25994100055802
LED 3156, 3155 4K	BP				93116747	5994100052357	25994100052351
LED 3156, 3155 6K	BP				93116746	5994100052364	25994100052368
LED 3157, 4157 4K	BP				93116749	5994100052371	25994100052375
LED 3157, 4157 6K	BP				93116748	5994100052388	25994100052382
LED 7440, W21W 4K	BP				93116741	5994100052746	25994100052740

GE/Tungsrām cross reference

Lamp Type	Pack Type	GE			TUNGSRAM		
		SKU	UPC	GTIN	SKU2	UPC2	GTIN2
LED 7440, W21W 6K	BP				93116740	5994100052753	25994100052757
LED 7440R, W21WR	BP				93116744	5994100052760	25994100052764
LED 7443, W21/5W 4K	BP				93116743	5994100052715	25994100052719
LED 7443, W21/5W 6K	BP				93116742	5994100052722	25994100052726
LED 7443R, W21/5WR	BP				93116745	5994100052739	25994100052733
LED DE3021, DE3022 6K	BP				93117369	5994100055761	25994100055765
LED DE3175, DE3022 6K	BP				93117371	5994100055785	25994100055789
LED DE3425, C5W	BP				93117372	5994100055792	25994100055796
LED P21/5W, 1157, 2057 4K	BP				93116737	5994100052654	25994100052658
LED P21/5W, 1157, 2057 6K	BP				93116736	5994100052661	25994100052665
LED P21/5W R, 1157R, 2057R	BP				93116739	5994100052678	25994100052672
LED P21W, 1156, 1141 4K	BP				93116735	5994100052685	25994100052689
LED P21W, 1156, 1141 6K	BP				93116734	5994100052692	25994100052696
LED P21W R, 1156R, 1141R	BP				93116738	5994100052708	25994100052702
P21/4W	BP	77870	43168275613	00043168778701	93116468	5994100050728	25994100050722
P21/5W	BP	77861	43168233033	00043168778619	93116466	5994100050704	25994100050708
P21/5W	Boxed	83506	43168835060	10043168835067	93116002	5994100046578	25994100046572
P21/5W NH	BP	73593	43168892469	00043168735933	93116414	5994100050186	25994100050180
P21W	BP	77862	43168233064	00043168778626	93116467	5994100050711	25994100050715
P21W NH	BP	73594	43168892476	00043168735940	93116415	5994100050193	25994100050197
P21W 24V HD	Boxed	94853	43168948531	10043168948538	93116058	5994100047131	25994100047135
PY21W	BP	77875	43168413701	00043168778756	93116470	5994100050742	25994100050746
R5W	BP	77387	43168233149	00043168773874	93116454	5994100050582	25994100050586
R10W	BP	77388	43168233224	00043168773881	93116455	5994100050599	25994100050593
T4W	BP	78206	43168233187	00043168782067	93116482	5994100050865	25994100050869
W5W	BP	78565	43168275637	00043168785655	93116489	5994100050933	25994100050937
W5W LL	BP	93011	43168678957	00043168930116	93116804	5994100052913	25994100052917
4405	Boxed	24425	43168244251	10043168244258	93115717	5994100045045	25994100045049
4416	Boxed	22983	43168960083	00043168229838	93115716	5994100045038	25994100045032

Lamp Type	Pack Type	GE			TUNGSRAM		
		SKU	UPC	GTIN	SKU2	UPC2	GTIN2
4505	Boxed	24640	43168961790	00043168246408	93115718	5994100045052	25994100045056
4509	Boxed	24650	43168246507	10043168246504	93115719	5994100045069	25994100045063
4515	Boxed	24673	43168246736	10043168246733	93115720	5994100045076	25994100045070
4537	Boxed	24742	43168247429	10043168247426	93115721	5994100045083	25994100045087
4880	Boxed	24995	43168961776	00043168249959	93115722	5994100045090	25994100045094
4411-3	Boxed	29040	43168290401	10043168290408	93115726	5994100045137	25994100045131
4537-2	Boxed	40822	43168961721	00043168408226	93115728	5994100045144	25994100045148
H4515	Boxed	33948	43168339483	10043168339480	93115727	5994100045151	25994100045155
H4651	Boxed	18532	43168961219	00043168185325	93115708	5994100044352	25994100044356
H4656	Boxed	18533	43168961226	00043168185332	93115709	5994100044369	25994100044363
H4656 NH	Boxed	25098	43168250986	10043168250983	93115724	5994100045113	25994100045117
H4666/H4668	Boxed	18535	43168961547	00043168185356	93115711	5994100044383	25994100044387
H5024	Boxed	19428	43168960267	00043168194280	93115714	5994100045014	25994100045018
H5051	Boxed	19411	43168960281	00043168194112	93115712	5994100044390	25994100044394
H5054	Boxed	19429	43168960311	00043168194297	93115715	5994100045021	25994100045025
H5062	Boxed	19412	43168960298	00043168194129	93115713	5994100044406	25994100044400
H6024	Boxed	18525	43168961264	00043168185257	93115707	5994100044345	25994100044349
H6024 NH	Boxed	28153	43168281539	10043168281536	93115725	5994100045120	25994100045124
H6054	Boxed	18534	43168961271	00043168185349	93115710	5994100044376	25994100044370
H6054 NH	Boxed	25097	43168250979	10043168250976	93115723	5994100045106	25994100045100
LED 7" ROUND	Boxed	69821	43168698214	10043168698211	93112881	5994100029540	25994100029544
LED 5X7	Boxed	69822	43168698221	10043168698228	93112882	5994100029557	25994100029551
LED 4X6 HIGH	Boxed	93411	43168934114	10043168934111	93112884	5994100029571	25994100029575
LED 4X6 LOW	Boxed	93403	43168934039	10043168934036	93112883	5994100029564	25994100029568

TUNGSRAM PACKAGING

BLISTER (BP)



PLASTIC BOX (PB)

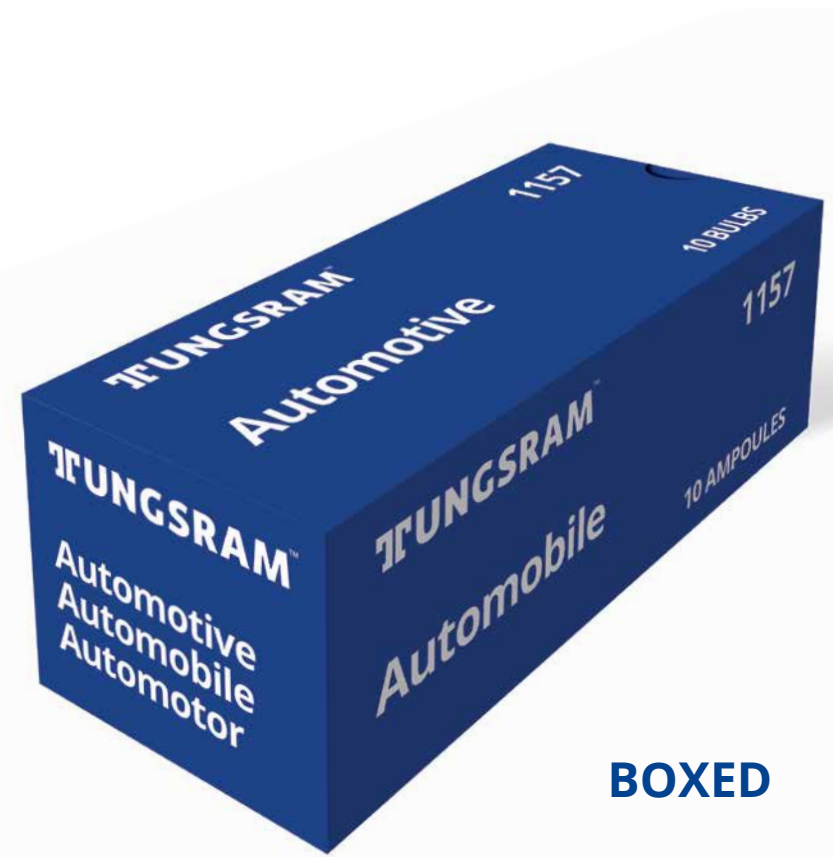

BOXED

LAMP LOCATOR

The lamps listed here are not to scale. To determine the diameter of a bulb in inches, multiply the bulb number by one-eighth. For example T-2 means approximately 2/8" or 1/4" diameter.

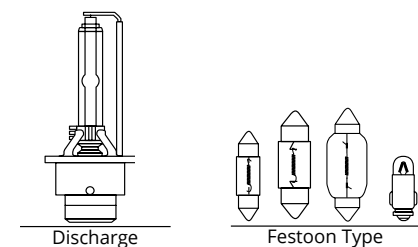
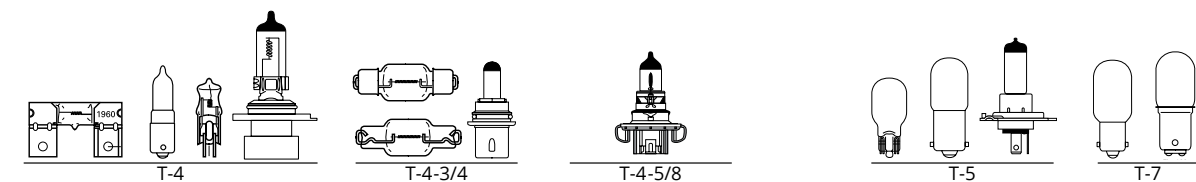
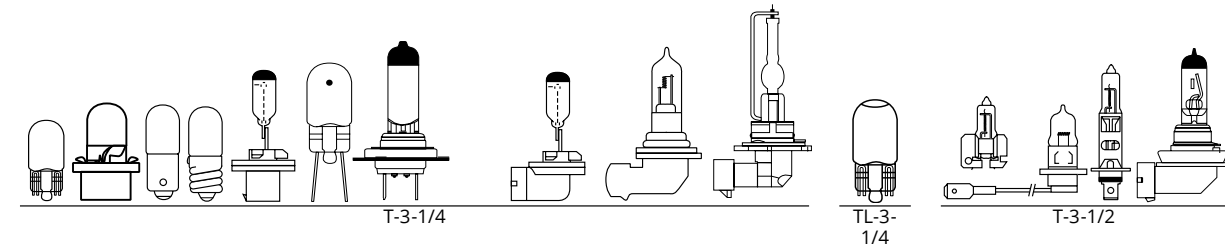
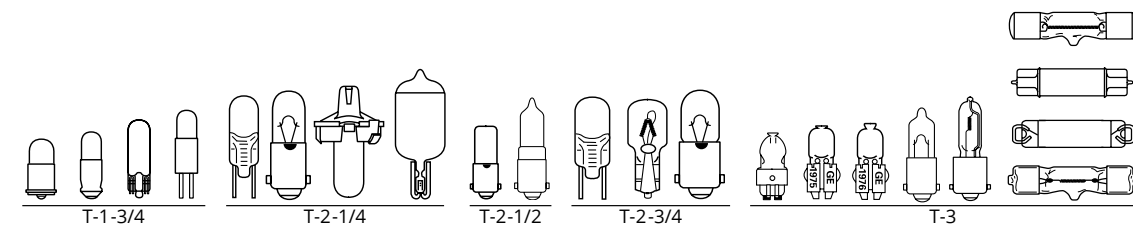
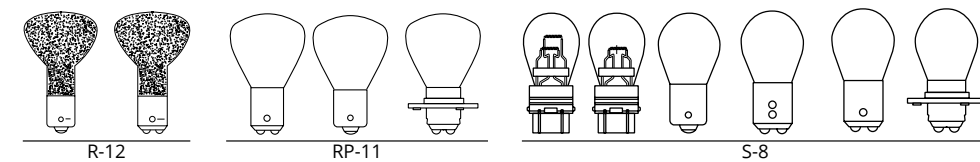
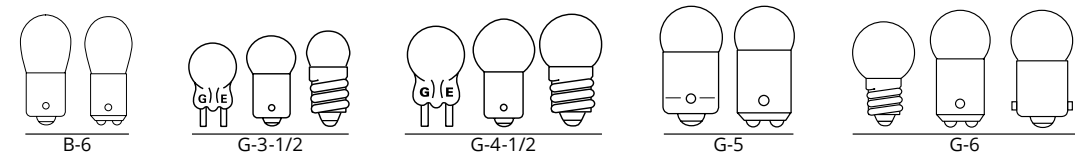

MINIATURE BASES

Bases provide electrical contact to the lamp and, in most cases, also support the lamp in the fixture. For miniature and subminiature lamps, bayonet or wedge base types are generally preferred over screw types when vibration is present.

In addition, wedge bases reduce socket size and complexity. Flanged or collared types are usually associated with requirements for filament location.

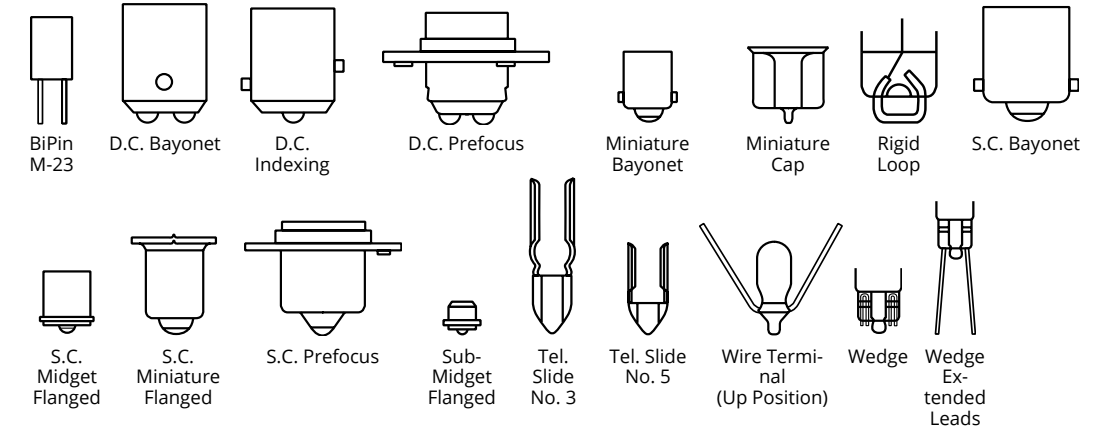

SEALED BEAM LAMPS

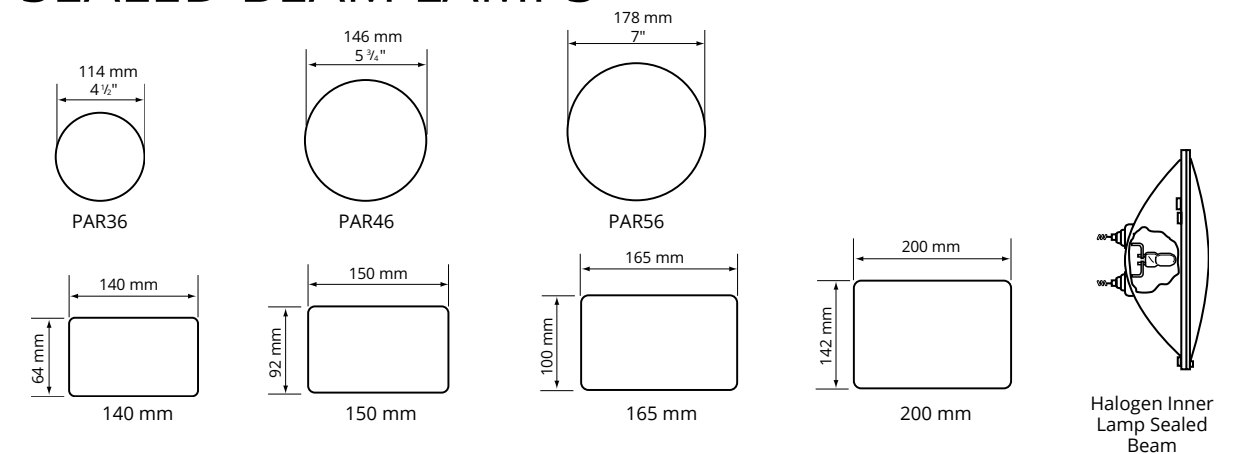

SEALED BEAM BASES

Bases provide electrical contact to the lamp. The most common bases for sealed beam lamps are the screw terminal and contact lug types. Other types are also available, as illustrated.

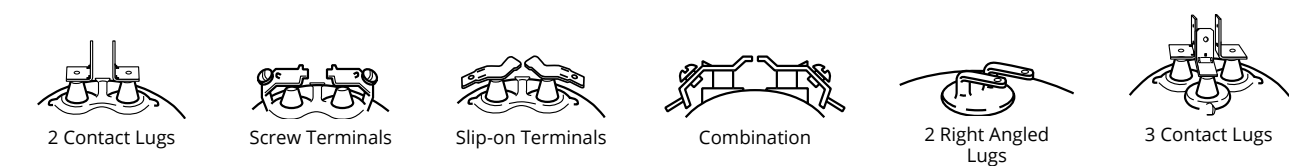

PRODUCT ORDERING INFORMATION

Lamps are designed for those applications requiring specific bulb size, base, and voltage. These lamps are operated on vehicles (cars, trucks, boats, aircraft, tractors) or in special applications utilizing low voltage sources. Most lamps are designated by common ANSI (American National Standards Institute) lamp numbers and lamps in this section are arranged in numerical order. To assist you in identifying lamps, drawings (not to scale) are provided, along with descriptions of bulb and base sizes.

Specific market segments covered in this section are products used in:

- Aircraft Emergency Building Lighting Marine
- Automotive Flashlight/Hand Lanterns Medical/Instruments
- Agriculture Garden/Outdoor Telephone
- CIM/Tractor Indicator Toys/Entertainment

FINDING AND ORDERING A LAMP

Most lamps have a number on the base or bulb. Generally it will match the lamp number in this catalog, which is sorted in numeric order (prefixes last). Often the first prefix is another lamp manufacturer's identification and can be ignored. You can verify the lamp using the drawings provided. Order codes for Blister and Unit are provided.

FORMULAS

The following are commonly used formulas to assist any calculations you may need.

- Watts = Volts x Amps
- Lumens = 12.57 x Mean Spherical Candelpower
- Kelvin = Celsius + 273
- Hot Resistance (Ohms) = Volts/Amps

ABBREVIATIONS

The abbreviations used in this catalog include:

A	Amperes	PAR	Parabolic Aluminized Reflector
ANSI	American National Standards Institute	Pf.	Prefocus
Bay.	Bayonet	SAE	Society of Automotive Engineers (US Motor Vehicle Standards)
D.C.	Double Contact	Sc.	Screw
Flg.	Flanged	S.C.	Single Contact
HID	High Intensity Discharge	Spec.	Special
LCL	Light Center Length	Tel.	Telephone
Min.	Miniature	Term.	Terminals
MOL	Maximum Overall Length	V	Volts
MSCP	Mean Spherical Candelpower	W	Watts
Nom.	Nominal		
C.I.M.	Construction & Industrial Machinery		
C.P.	Candelpower		

LAMP PREFIXES

DE	Double-Ended	Q	Quartz Halogen
H	Halogen	W,T,R	European Designation
K	Krypton Gas	C,P	
PR	Prefocus Base (e.g., "Flashlight Lamp")	D	Discharge

LAMP SUFFIXES

A	Amber	X	Indicates some arbitrary deviation from the normal product
HD	Heavy Duty	-1	Slip-on terminals
LL	Long Life	-2	Represents various deviations
NH	Nighthawk™	-3	Represents deviations (e.g. combination terminal)
NHP	Nighthawk™ Platinum		
NHX	Nighthawk™ Xenon		
NA	Natural Amber (automotive lighting)		
R	Red		

HEADINGS IN THIS CATALOG SECTION

The following terms and descriptions can help you when checking Halogen lamp specifications and when ordering products. Within each product line, lamps are divided into families. Within families, lamps are listed by wattage. In each of these groups, lamps are listed alphabetically by bulb shape.

Lamp No.	Order Code	Pack Type	Case Qty	Primary Application	DOT	Volts	Amps (A) or Watts (W)	MSCP	Bulb	Base	Filament	LCL (in)	MOL (in)	Rated Life (hrs)	Warning and Caution Notices
HB2 (9003)	93116334	BP	1/6	Auto headlamp	Yes	12	60/55	119.0/72.0	T4 3/4	P43t-38	C-8/C-8	1.12	3.62	185/750	306
HB2 (9003)	93116498	BP	1/3 set												

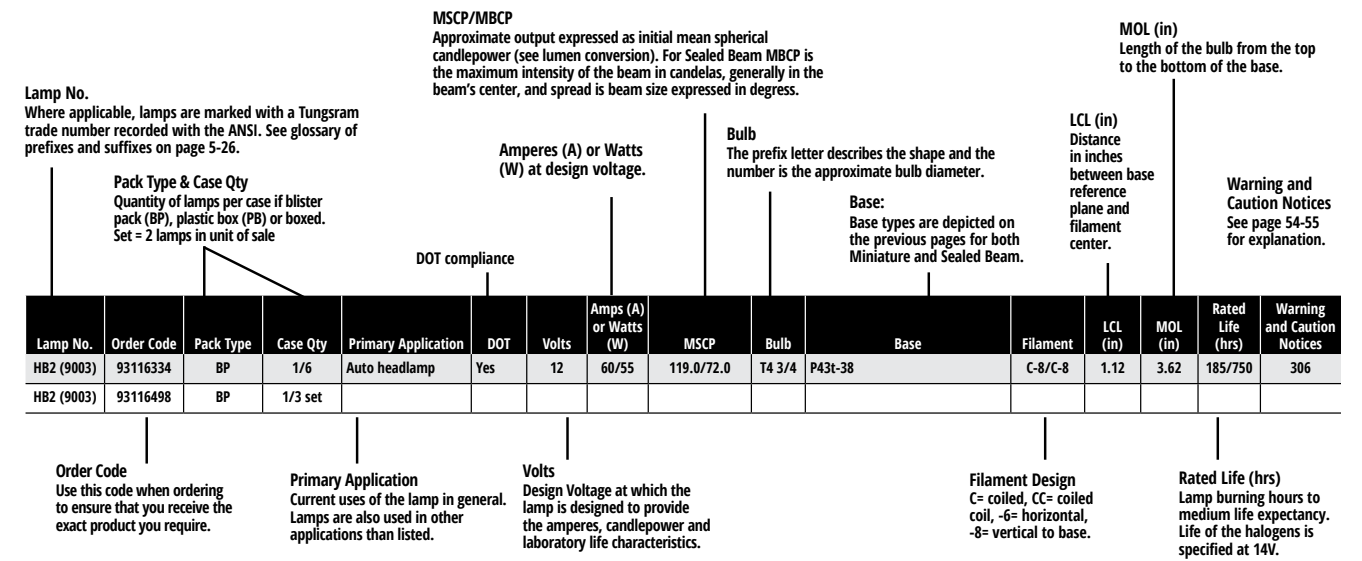

Miniature and Headlight Lamps

Lamp No.	Order Code	Pack Type	Case Qty	Primary Application	DOT	Volts	Amps (A) or Watts (W)	MSCP	Bulb	Base	Filament	LCL (in)	MOL (in)	Rated Life (hrs)	Warning and Caution Notices
24	93116828	Boxed	1/10/50	Auto Mini		14	.24A	2	T2 3/4	Wedge (W2.1x9.5d)	C-2V	0,46	0,91	1500	-
37	93116480	BP	1/6 set	Auto Mini		14	.09A	0,5	T1 3/4	Wedge (W2.1x4.9d)	C-2F	0,4	0,8	1500	-
37	93116289	Boxed	1/10/50												
44	93116024	Boxed	1/10/50	Indicator		6,3	.25A	0,9	T3 1/4	Miniature Bayonet (Ba9s)	C-2R	0,78	1,19	3000	-
47	93116025	Boxed	1/10/50	Indicator		6,3	.15A	0,52	T3 1/4	Miniature Bayonet (Ba9s)	C-2R	0,78	1,19	3000	-
53	93116445	BP	1/6 set	Indicator		14,4	.12A	1	G3 1/2	Miniature Bayonet (Ba9s)	C-2V	0,5	0,94	1000	-
53	93116026	Boxed	1/10/50												
55	93116829	Boxed	1/10/50	Indicator		7	.41A	2	G4 1/2	Miniature Bayonet (Ba9s)	C-2R	0,56	1,07	500	-
57	93116446	BP	1/6 set	Auto Mini		14	.24A	2	G4 1/2	Miniature Bayonet (Ba9s)	C-2V	0,56	1,07	500	-
57	93116028	Boxed	1/10/50												
63	93116448	BP	1/6 set	Coin Machine		7	.63A	3	G6	Single Contact Bayonet (BA15s)	C-2R	0,75	1,44	1000	-
67	93116450	BP	1/6 set	Auto Mini		13,5	.59A	4	G6	Single Contact Bayonet (BA15s)	C-2R	0,81	1,44	5000	-
67	93116030	Boxed	1/10/50												
67 NH	93116404	BP	1/6 set	Auto Mini		13,5	.59A	4	G6	Single Contact Bayonet (BA15s)	C-2R	0,81	1,44	5000	-
68	93116031	Boxed	1/10/50	Auto, Marine		13,5	.59A	4	G6	Double Contact Bayonet (BA15d)	C-2R	0,81	1,44	5000	-
73	93116479	BP	1/6 set	Auto Mini		14	.08A	0,3	T1 3/4	Wedge (W2.1x4.9d)	C-2F	0,4	0,8	15000	-
73	93116283	Boxed	1/10/50												
74	93116478	BP	1/6 set	Auto Mini		14	.10A	0,7	T1 3/4	Wedge (W2.1x4.9d)	C-2F	0,4	0,8	1000	-
74	93116290	Boxed	1/10/50												
85	93115739	Boxed	1/10/50	Indicator		28	.04A	0,3	T1 3/4	Wedge (W2.1x9.5d)	C-2F	0,4	0,8	7000	-
88	93115883	Boxed	1/10/50	Indicator		6,8	1.91A	15	S8	Double Contact Bayonet (BA15d)	C-6	1,12	2	300	-
89	93116451	BP	1/6 set	Auto Mini		13	.58A	6	G6	Single Contact Bayonet (BA15s)	C-2R	0,75	1,44	750	-
89	93116033	Boxed	1/10/50												
89 LL	93116387	BP	1/6 set	Auto Mini		13	.58A	6	G6	Single Contact Bayonet (BA15s)	C-2R	0,75	1,44	750	-

For the most up-to-date product information, see www.tungsr.com.

Miniature and Headlight Lamps (continued)

Lamp No.	Order Code	Pack Type	Case Qty	Primary Application	DOT	Volts	Amps (A) or Watts (W)	MSCP	Bulb	Base	Filament	LCL (in)	MOL (in)	Rated Life (hrs)	Warning and Caution Notices
90	93116452	BP	1/6 set	Auto, Marine		13	.58A	6	G6	Double Contact Bayonet (BA15d)	C-2R	0,75	1,44	750	-
90	93116034	Boxed	1/10/50												
93	93116465	BP	1/6 set	Auto Mini		12,8	1.04A	15	S8	Single Contact Bayonet (BA15s)	C-6	1,12	2	700	-
93	93116045	Boxed	1/10/50												
93 HI	93116520	BP	1/6 set	Auto Mini		12,8	13W	15	S8	Single Contact Bayonet (BA15s)	C-6	1,25	2,02	700	-
93 NH	93116409	BP	1/6 set	Auto Mini		12,8	1.04A	15	S8	Single Contact Bayonet (BA15s)	C-6	1,12	2	700	-
94	93116306	Boxed	1/10/50	Auto and Marine		12,8	1.04A	15	S8	Double Contact Bayonet (BA15d)	C-6	1,12	2	700	-
97	93116449	BP	1/6 set	Auto Mini		13,5	.69A	4	G6	Single Contact Bayonet (BA15s)	C-2V	0,81	1,44	5000	-
97	93116047	Boxed	1/10/50												
161	93116488	BP	1/6 set	Auto Mini		14	.19A	1	T3 1/4	Wedge (W2.1x9.2d)	C-2F	0,56	1,06	1500	-
161	93116009	Boxed	1/10/50												
161 NH	93116423	BP	1/6 set	Auto Mini		14	.19A	1	T3 1/4	Wedge (W2.1x9.2d)	C-2F	0,56	1,06	1500	-
168	93116486	BP	1/6 set	Auto Mini		14	.35A	3	T3 1/4	Wedge (W2.1x9.2d)	C-2F	0,56	1,06	1500	-
168	93116010	Boxed	1/10/50												
168 NH	93116424	BP	1/6 set	Auto Mini		14	.35A	3	T3 1/4	Wedge (W2.1x9.2d)	C-2F	0,56	1,06	1500	-
193	93116015	Boxed	1/10/50	Auto Mini		14	.33A	2	T3 1/4	Wedge (W2.1x9.5d)	C-2F	0,56	1,06	15000	-
194	93116487	BP	1/6 set	Auto Mini		14	.27A	2	T3 1/4	Wedge (W2.1x9.2d)	C-2F	0,56	1,06	2500	-
194	93116016	Boxed	1/10/50												
194 LL	93116399	BP	1/6 set	Auto Mini		14	.27A	2	T3 1/4	Wedge (W2.1x9.2d)	C-2F	0,56	1,06	12000	-
194 NH	93116425	BP	1/6 set	Auto Mini		14	.27A	2	T3 1/4	Wedge (W2.1x9.2d)	C-2F	0,56	1,06	1500	-
194NA	93116485	BP	1/6 set	Auto Mini		14	.27A	1,5	T3 1/4	Wedge (W2.1x9.2d)	C-2F	0,56	1,06	2500	-
194NA	93116017	Boxed	1/10/50												
194NA LL	93116400	BP	1/6 set	Auto Mini		14	.27A	2	T3 1/4	Wedge (W2.1x9.2d)	C-2F	0,56	1,06	5000	-
194NA NH	93116422	BP	1/6 set	Auto Mini		14	.27A	2	T3 1/4	Wedge (W2.1x9.2d)	C-2F	0,56	1,06	1500	-
199	93116018	Boxed	1/10/50	Truck Signal-Heavy Duty		12,8	2.25A	32	S8	Single Contact Bayonet (BA15s)	C-6	1,25	2	1200	-
210	93115884	Boxed	1/10/50	Indicator		6,5	1.78A	15	B6	Double Contact Bayonet (BA15d)	C-6	1,06	1,75	100	-
211-2	93116439	BP	1/6 set	Auto Mini		12,8	.97A	12	T3	Miniature Cap	C-8	-	1,72	1000	-
211-2	93116021	Boxed	1/10/50												
211-2 NH	93116401	BP	1/6 set	Auto Mini		12,8	.97A	12	T3	Miniature Cap	C-8	-	1,72	1000	-
212-2	93116441	BP	1/6 set	Auto Mini		13,5	.74A	6	T3	Miniature Cap	C-8	-	1,72	5000	-
265	93115740	Boxed	1/10/50	Indicator		28	.08A	0,75	G3 1/2	Miniature Bayonet (Ba9s)	C-2F	0,5	0,94	5000	-
303	93115741	Boxed	1/10/50	Aircraft		28	.30A	6	G6	Single Contact Bayonet (BA15s)	C-2F	0,75	1,44	500	-
304	93115742	Boxed	1/10/50	Aircraft		28	.30A	6	G6	Double Contact Bayonet (BA15d)	C-2F	0,75	1,44	500	-
305	93115885	Boxed	1/10/50	Aircraft		28	.51A	15	S8	Single Contact Bayonet (BA15s)	C-2V	1,12	2	300	-
306	93115886	Boxed	1/10/50	Aircraft		28	.51A	15	S8	Double Contact Bayonet (BA15d)	C-2V	1,12	2	300	-
307	93115897	Boxed	1/10/50	Aircraft		28	.67A	21	S8	Single Contact Bayonet (BA15s)	C-2V	1,12	2	300	-
308	93115898	Boxed	1/10/50	Aircraft		28	.67A	21	S8	Double Contact Bayonet (BA15d)	C-2V	1,12	2	300	-
313	93115743	Boxed	1/10/50	Aircraft		28	.17A	3,5	T3 1/4	Miniature Bayonet (Ba9s)	C-2F	0,62	1,19	500	-
316	93115744	Boxed	1/10/50	Aircraft		6	.70A	3,4	T3 1/4	Miniature Bayonet (Ba9s)	C-2R	0,62	1,19	500	-
327	93115900	Boxed	1/10/50	Aircraft		28	.04A	0,34	T1 3/4	S.C. Midget Flanged	C-2F	0,38	0,63	4000	-
356	93115730	Boxed	1/10/50	Aircraft		28	.17A	3,5	G3 1/2	Miniature Bayonet (Ba9s)	C-2F	0,5	0,94	500	-
382	93115901	Boxed	1/10/50	Auto Mini		14	.08A	0,3	T1 3/4	S.C. Midget Flanged	C-2F	0,38	0,63	40000	-
400	93115896	Boxed	1/10/50	Aircraft		28	.10A	1,6	T3 1/4	Wedge (W2.1x9.5d)	C-2F	0,56	1,06	1000	-
456	93115887	Boxed	1/10/50	Instrument		28	.17A	2	G4 1/2	Miniature Bayonet (Ba9s)	C-2F	0,56	1,07	5000	-
464	93115737	Boxed	1/10/50	Aircraft		28	.17A	3	T3 1/4	Wedge (W2.1x9.5d)	C-2F	0,56	1,06	1500	-
561	93116438	BP	1/6 set	Auto Mini		12,8	.97A	12	T3	Rigid Loop	C-8	-	1,72	1000	-
561	93116027	Boxed	1/10/50												
562	93116440	BP	1/6 set	Auto Mini		13,5	.74A	6	T3	Rigid Loop	C-8	-	1,72	2000	-

For the most up-to-date product information, see www.tungsr.com.

Miniature and Headlight Lamps (continued)

Lamp No.	Order Code	Pack Type	Case Qty	Primary Application	DOT	Volts	Amps (A) or Watts (W)	MSCP	Bulb	Base	Filament	LCL (in)	MOL (in)	Rated Life (hrs)	Warning and Caution Notices
590	93115729	Boxed	1/10/50	Auto Mini		13,5	.37A	4	T3 1/4	Wedge (W2.1x9.5d)	C-2V	0,5	1,06	2000	-
623	93115745	Boxed	1/10/50	Instrument		28	.37A	6	G6	Single Contact Bayonet (BA15s)	2C-2V	0,75	1,44	1000	-
631	93116453	BP	1/6 set	Auto Mini		14	.63A	6	G6	Single Contact Bayonet (BA15s)	2C-2R	0,75	1,44	1000	-
631	93116029	Boxed	1/10/50												
658	93115752	Boxed	1/10/50	Auto Mini		14	.08A	0,3	T3 1/4	Wedge (W2.1x9.5d)	C-2F	0,56	1,06	15000	-
755	93116032	Boxed	1/10/50	Indicator		6,3	.15A	0,3	T3 1/4	Miniature Bayonet (Ba9s)	C-2R	0,78	1,19	20000	-
756	93115731	Boxed	1/10/50	Auto Mini		14	.08A	0,31	T3 1/4	Miniature Bayonet (Ba9s)	C-2F	0,62	1,19	15000	-
757	93115746	Boxed	1/10/50	Indicator		28	.08A	0,6	T3 1/4	Miniature Bayonet (Ba9s)	C-2F	0,62	1,19	15000	-
862	93116363	Boxed	1/10	Tractor		12,8	37.5W	60	T3 1/4	Right Angle Prefocus (PGJ13)	C-6	1,25	2,68	1000	306
880	93116318	BP	1/6	Auto Fog		12,8	27W	38	T3 1/4	Axial Plastic (PG13)	C-6	1,25	2,68	900	306
881	93116319	BP	1/6	Auto Fog		12,8	27W	38	T3 1/4	Right Angle Prefocus (PGJ13)	C-6	1,25	2,68	900	306
885	93116320	BP	1/6	Auto Fog		12,8	50W	99	T3 1/4	Axial Plastic (PG13)	C-6	1,25	2,68	200	306
886	93116325	BP	1/6	Auto Fog		12,8	50W	99	T3 1/4	Right Angle Prefocus (PGJ13)	C-6	1,25	2,68	200	306
889	93116321	BP	1/6	Auto Fog		12,8	27W	43	T3 1/4	Right Angle Prefocus (PGJ13)	C-6	1	2,68	300	306
892	93116359	Boxed	1/10	Auto Fog		12,8	16W	28	T3 1/4	Axial Plastic (PG13)	C-6	1	2,68	300	306
893	93116322	BP	1/6	Auto Fog		12,8	37.5W	75	T3 1/4	Axial Plastic (PG13)	C-6	1,25	2,68	220	306
894	93116329	BP	1/6	Tractor		12,8	37.5W	75	T3 1/4	Right Angle Prefocus (PGJ13)	C-6	1,25	2,68	220	306
894	93116360	Boxed	1/10												
896	93116330	BP	1/6	Auto Fog		12,8	37.5W	75	T3 1/4	Right Angle Prefocus (PGJ13)	C-6	1,25	2,68	220	306
898	93116331	BP	1/6	Auto Fog		12,8	37.5W	60	T3 1/4	Right Angle Prefocus (PGJ13)	C-6	1,25	2,68	1000	306
898	93116364	Boxed	1/10												
899	93116328	BP	1/6	Auto Fog		12,8	2.93A	60	T3 1/4	Axial Plastic Prefocus (PG13)	C-6	1,25	2,68	1000	306
904	93116492	BP	1/6 set	Auto Mini		13,5	.69A	4	T5	Wedge (W2.1x9.5d)	C-2F	0,81	1,49	5000	-
904	93116035	Boxed	1/10/50												
906	93116491	BP	1/6 set	Auto Mini		13	.69A	6	T5	Wedge (W2.1x9.2d)	C-2F	0,81	1,49	1000	-
906	93116036	Boxed	1/10/50												
908	93116037	Boxed	1/10/50	Emergency Lighting		6	1.50A	12	T5	Wedge (W2.1x9.5d)	C-2R	0,81	1,49	50	-
909	93116038	Boxed	1/10/50	Emergency Lighting		6	.62A	3	T5	Wedge (W2.1x9.5d)	C-2R	0,81	1,49	50	-
912	93116490	BP	1/6 set	Auto Mini		12,8	1.00A	12	T5	Wedge (W2.1x9.2d)	C-2R	0,81	1,49	1000	-
912	93116039	Boxed	1/10/50												
912 NH	93116428	BP	1/6 set	Auto Mini		12,8	1.00A	12	T5	Wedge (W2.1x9.2d)	C-2R	0,81	1,49	1000	-
915	93116040	Boxed	1/10/50	Emergency Lighting		12	.75A	11	T5	Wedge (W2.1x9.5d)	C-2R	0,81	1,49	50	-
916	9														

Miniature and Headlight Lamps (continued)

Lamp No.	Order Code	Pack Type	Case Qty	Primary Application	DOT	Volts	Amps (A) or Watts (W)	MSCP	Bulb	Base	Filament	LCL (in)	MOL (in)	Rated Life (hrs)	Warning and Caution Notices
3357/3457	93116475	BP	1/6 set	Auto Exterior		12.8/14	2.1/1.59A	30/2.2	S8	Plastic Wedge (W2.5x16q)	C-6/C-6	1,1	2,09	400/5000	-
3357/3457	93116304	Boxed	1/10/50												
3357/3457 LL	93116393	BP	1/6 set	Auto Exterior		12.8/14	2.1/1.59A	30/2.2	S8	Plastic Wedge (W2.5x16q)	C-6/C-6	1,1	2,09	800/10000	-
3357/3457 NH	93116418	BP	1/6 set	Auto Exterior		12.8/14	2.1/1.59A	30/2.2	S8	Plastic Wedge (W2.5x16q)	C-6/C-6	1,1	2,09	200/5000	-
3357/3457NA	93116476	BP	1/6 set	Auto Exterior		12.8/14	2.1/1.59A	30/2.2	S8	Plastic Wedge (W2.5x16q)	C-6/C-6	1,1	2,09	400/5000	-
3357/3457NA	93116305	Boxed	1/10/50												
3757NA	93116481	BP	1/6 set	Auto Exterior		12	2.1/1.59A	32/3	S8	Wedge (W2.5x16q)	C-6	1,1	2,13	1200/5000	-
3757NA	93116827	Boxed	1/10/50												
4057 LL	93116398	BP	1/6 set	Auto Exterior		12	2.23/48A	32/2	S8	Plastic Wedge (W2.5x16q)	C-6/C6	1,1	2,15	4000/10000	-
4114 LL	93116397	BP	1/6 set	Auto Exterior		12	2.23/59A	32/3	S8	Plastic Wedge (W2.5x16q)	C-6	1,1	2,13	4000/10000	-
4114 LL	93116826	Boxed	1/10/50												
4157 LL	93116377	BP	1/6 set	Auto Exterior		12.8/14	2.23/59A	32/3	S8	Plastic Wedge (W2.5x16q)	C-6/C-6	1,1	2,09	3600/10000	-
4157NA LL	93116396	BP	1/6 set	Auto Exterior		12.8/14	2.23/59A	24/2.2	S8	Plastic Wedge (W2.5x16q)	C-6/C-6	1,1	2,09	3600/10000	-
4157NA LL	93116296	Boxed	1/10/50												
7440	93116483	BP	1/6 set	Auto, Japanese Vehicles		13,5	21W	37	T7	Wedge (W3x16d)	C-6	1,14	1,85	500	-
7440	93116298	Boxed	1/10/50												
7443	93116484	BP	1/6 set	Auto, Japanese Vehicles		13.5/13.5	21/5W	35/3	T7	Wedge (W3x16q)	C-6/C-6	1,14	1,85	500/1000	-
7443	93116297	Boxed	1/10/50												
7443 NH	93116421	BP	1/6 set	Auto, Japanese Vehicles		13.5/13.5	21/5W	35/3	T7	Wedge (W3x16q)	C-6/C-6	1,14	1,85	500/1000	-
7443NA	93116502	BP	1/6 set	Auto, Japanese Vehicles		13.5/13.5	21/5W	35/3	T7	Wedge (W3x16q)	C-6/C-6	1,14	1,85	500/1000	-
C5W	93116442	BP	1/6 set	Auto Mini		13,5	4W	3,6	T3 1/2	Festoon (SV8.5/8)	C-8	0,59	1,45	1830	-
D1R	93116614	Boxed	1/4	Auto Discharge-Reflector	Yes	-	35W	223	T	PK32d-3	-	1,07	3,09	2790	310
D1S	93115997	Boxed	1/4	Auto Discharge-Reflector	Yes	-	35W	255	T	PK32d-2	-	1,07	3,09	2845	310
D2R	93116048	Boxed	1/3	Auto Discharge-Reflector	Yes	-	35W	223	T3	P32d-3	-	1,07	3,09	2845	310
D2S	93116049	Boxed	1/3	Auto Discharge-Reflector	Yes	-	35W	255	T3	P32d-2	-	1,07	3,09	2845	310
D3R	93116615	Boxed	1/4	Auto Discharge-Reflector	Yes	-	35W	223	T4	PK32d-6	-	1,07	3,09	2790	313
D3S	93116613	Boxed	1/4	Auto Discharge-Reflector	Yes	-	35W	255	T	PK32d-5	-	1,07	3,09	2790	313
D4R	93116612	Boxed	1/3	Auto Discharge-Reflector	Yes	-	35W	223	T	P32d-6	-	1,07	3,09	2790	313
D4S	93116611	Boxed	1/3	Auto Discharge-Reflector	Yes	-	35W	255	T	P32d-5	-	1,07	3,09	2790	313
DE3021	93116444	BP	1/6 set	Auto Mini		14	.24A	2	T2 1/4	Festoon (SV7MM)	C-8	-	1,15	1000	-
DE3022	93116431	BP	1/6 set	Auto Mini		13	.38A	3	T2 1/4	Festoon (SV7MM)	C-8	-	1,18	1000	-
DE3175	93116293	Boxed	1/10/50	Auto Mini		13	.77A	9,55	T3 1/4	Festoon (SV8.5MM)	C-8	-	1,25	400	-
DE3175	93116437	BP	1/6 set												
DE3175 NH	93116402	BP	1/6 set	Auto Mini		13	.77A	9,55	T3 1/4	Festoon (SV8.5MM)	C-8	-	1,25	400	-
DE7576	93116443	BP	1/6 set	Auto Mini		13,5	10W	9,8	T3 1/2	Festoon (SV8.5MM)	C-8	-	1,65	745	-
H1-55	93116338	BP	1/6	Auto Headlamp	Yes	12,8	55W	112	T3 1/2	P14.5s	C-8	1,08	2,66	560	308
H1-55	93116051	Boxed	1/10												
H1-55 NH	93116351	BP	1/6	Auto Headlamp	Yes	12,8	55W	112	T3 1/2	P14.5s	C-8	1,08	2,66	280	308
H1-55 NH	93116503	BP	1/3 set												
H1-55 NHX	93116378	PB	1/3 set	Auto Headlamp	Yes	12,8	55W	112	T3 1/2	P14.5s	C-8	1,08	2,46	125	308
H1-70 24V	93116052	Boxed	1/10	EU bus, trucks		28	70W	151	T3 1/2	P14.5s	C-8	1,08	2,46	560	308
H1-70 24V HDLL	93115998	Boxed	1/10	EU bus, trucks		28	70W	151	T4	P14.5s	C-8	1,08	2,46	720	308
H3-35	93116323	BP	1/6	Auto Fog		13,2	55W	104	T3 1/2	PK22s	C-6	0,71	1,65	320	308
H3-55	93116053	Boxed	1/10	Auto Fog		13,2	55W	104	T3 1/2	PK22s	C-6	0,71	1,65	320	308
H3-70 24V	93116054	Boxed	1/10	EU bus, trucks		28	70W	139	T3 1/2	PK22S	C-6	0,71	1,65	740	308

For the most up-to-date product information, see www.tungsr.com.

Miniature and Headlight Lamps (continued)

Lamp No.	Order Code	Pack Type	Case Qty	Primary Application	DOT	Volts	Amps (A) or Watts (W)	MSCP	Bulb	Base	Filament	LCL (in)	MOL (in)	Rated Life (hrs)	Warning and Caution Notices
H3-70 24V HDLL	93116001	Boxed	1/10	EU bus, trucks		28	70W	139	T3 1/2	PK22s	C-6	0,71	1,65	1000	308
H3-100	93116324	BP	1/6	Auto Fog		13,2	100W	175	T3 1/2	PK22S	C-6	0,71	1,65	100	308
H4-60/55	93116326	BP	1/6	Auto ECE Headlamp		13,5	60/55W	131/80	T5	P43T-38	C-8/C-8	1,12	3,62	1400	308
H4-60/55	93116055	Boxed	1/10												
H4-60/55 NH	93116345	BP	1/6	Auto ECE Headlamp		13,2	60/55W	131/80	T5	P43t-38	C-8/C-8	1,12	3,62	150	308
H4-60/55 NHX	93116379	PB	1/3 set	Auto ECE Headlamp		13,2	60/55W	131/80	T5	P43T-38	C-8/C-8	1,12	3,62	125/125	308
H4-60/55 MS	93116344	BP	1/6	Auto ECE Headlamp		13,5	60/55W	131/80	T5	P43T-38	C-8/C-8	1,12	3,62	1400	308
H4-75/70 24V	93116056	Boxed	1/10	EU bus, trucks		28	75/70W	151/95	T5	P43t-38	C-8/C-8	1,14	3,62	450	308
H4-75/70 24V HDLL	93115999	Boxed	1/10	EU bus, trucks		28	75/70W	151/95	T5	P43T-38	C-8/C-8	1,12	3,62	650/1490	308
H7-55	93116335	BP	1/6	Auto Headlamp	Yes	12,8	55W	107	T3 1/2	PX26d	C-8	0,98	2,36	490	308
H7-55	93116057	Boxed	1/10												
H7-55 LL	93116315	BP	1/6	Auto Headlamp	Yes	12,8	55W	107	T3 1/2	PX26d	C-8	0,98	2,36	625	308
H7-55 NH	93116831	BP	1/6	Auto Headlamp	Yes	12,8	55W	107	T3 1/2	PX26d	C-8	0,98	2,36	250	308
H7-55 NH	93116504	BP	1/3 set												
H7-55 NHP	93116517	BP	1/3 set	Auto Headlamp	Yes	12,8	55W	107	T3 1/2	PX26d	C-8	0,98	2,36	175	308
H7-55 NHX	93116380	PB	1/3 set	Auto Headlamp	Yes	12,8	55W	107	T3 1/2	PX26d	C-8	0,98	2,36	130	308
H7-70 24V HDLL	93116000	Boxed	1/10	EU bus, trucks		28	70W	139	T3 1/2	PX26d	C-8	0,98	2,36	650	308
H8	93116336	BP	1/6	Auto Fog	Yes	12,8	35W	58	T3 1/2	PGJ19-1	C-8	1,06	2,63	700	308
H9	93116337	BP	1/6	Auto Headlamp	Yes	12,8	65W	159	T3 1/2	PGJ19-5	C-8	1,08	2,63	260	308
H11-55	93116341	BP	1/6	Auto Headlamp	Yes	12,8	55W	99	T3 1/2	PGJ19-2	C-8	1,07	2,63	660	308
H11-55	93116050	Boxed	1/10												
H11-55 LL	93116317	BP	1/6	Auto Headlamp	Yes	12,8	55W	99	T3 1/2	PGJ19-2	C-8	1,07	2,63	1000	308
H11-55 NH	93116511	BP	1/3 set	Auto Headlamp	Yes	12,8	55W	99	T3 1/2	PGJ19-2	C-8	1,07	2,63	350	308
H11-55 NHP	93116510	BP	1/3 set	Auto Headlamp	Yes	12,8	55W	99	T3 1/2	PGJ19-2	C-8	1,07	2,63	175	308
H11-55 NHX	93116385	PB	1/3 set	Auto Headlamp	Yes	12,8	55W	99	T3 1/2	PGJ19-2	C-8	1,07	2,63	125	308
H11B	93116343	BP	1/6	Auto Headlamp	Yes	12,8	55W	99	T3 1/2	PGJ19-2	C-8	1,07	2,63	1050	308
HB2 (9003)	93116334	BP	1/6	Auto Headlamp	Yes	12,8	60/55W	119/72	T4 3/4	P43t-38	C-8/C-8	1,12	3,62	185/750	306
HB2 (9003)	93116498	BP	1/3 set												
HB2 (9003)	93115996	Boxed	1/10												
HB2 (9003) LL	93116316	BP	1/6	Auto Headlamp	Yes	12,8	60/55W	119/72	T4 3/4	P43t-38	C-8/C-8	1,12	3,62	220/1400	306
HB2 (9003) NH	93116350	BP	1/6	Auto Headlamp	Yes	12,8	60/55W	119/72	T4 3/4	P43t-38	C-8/C-8	1,12	3,62	160/260	306
HB2 (9003) NH	93116509	BP	1/3 set												
HB2 (9003) NHP	93116512	BP	1/3 set	Auto Headlamp	Yes	12,8	60/55W	119/72	T4 3/4	P43t-38	C-8/C-8	1,12	3,62	125/175	306
HB2 (9003) NHX	93116381	PB	1/3 set	Auto Headlamp	Yes	12,8	60/55W	119/72	T4 3/4	P43t-38	C-8/C-8	1,12	3,62	125/110	306
HB1 (9004)	93116327	BP	1/6	Auto Headlamp	Yes	12,8	65/45W	95/55	T4 3/4	P29T	C-6/C-6	1,75	4,17	150/320	306
HB1 (9004)	93116499	BP	1/3 set												
HB1 (9004)	93116281	Boxed	1/10												
HB1 (9004) LL	93116309	BP	1/6	Auto Headlamp	Yes	12,8	65/45W	95/55	T4 3/4	P29T	C-6/C-6	1,75	4,17	150/850	306
HB1 (9004) LL	93116280	Boxed	1/10												
HB1 (9004) NH	93116349	BP	1/6	Auto Headlamp	Yes	12,8	65/45W	95/55	T4 3/4	P29T	C-6/C-6	1,75	4,17	100/200	306
HB1 (9004) NH	93116508	BP	1/3 set												
HB1 (9004) NHP	93116513	BP	1/3 set	Auto Headlamp	Yes	12,8	65/45W	95/55	T4 3/4	P29T	C-6/C-6	1,75	4,17	100/200	306
HB3 (9005)	93116332	BP	1/6	Auto Headlamp	Yes	12,8	60W	135	T4	P20d	C-8	1,24	3,13	350	306
HB3															

Miniature and Headlight Lamps (continued)

Lamp No.	Order Code	Pack Type	Case Qty	Primary Application	DOT	Volts	Amps (A) or Watts (W)	MSCP	Bulb	Base	Filament	LCL (in)	MOL (in)	Rated Life (hrs)	Warning and Caution Notices
HB3 (9005) NH	93116348	BP	1/6	Auto Headlamp	Yes	12,8	60W	135	T4	P20d	C-8	1,24	3,13	340	306
HB3 (9005) NH	93116507	BP	1/3 set												
HB3 (9005) NHP	93116514	BP	1/3 set	Auto Headlamp	Yes	12,8	60W	135	T4	P20d	C-8	1,24	3,13	100	306
HB3 (9005) NHX	93116382	PB	1/3 set	Auto Headlamp	Yes	12,8	60W	135	T4	P20d	C-8	1,24	3,13	100	306
9005XS LL	93116310	BP	1/6	Auto Headlamp	Yes	12,8	60W	135	T4	P20d straight	C-8	1,24	3,13	320	306
HB4 (9006)	93116340	BP	1/6	Auto Headlamp	Yes	12,8	51W	80	T4	P22d	C-8	1,24	3,13	1850	306
HB4 (9006)	93116500	BP	1/3 set												
HB4 (9006)	93115865	Boxed	1/10												
HB4 (9006) LL	93116313	BP	1/6	Auto Headlamp	Yes	12,8	51W	80	T4	P22d	C-8	1,24	3,13	1850	306
HB4 (9006) NH	93116347	BP	1/6	Auto Headlamp	Yes	12,8	51W	80	T4	P22d	C-8	1,24	3,13	1200	306
HB4 (9006) NH	93116506	BP	1/3 set												
HB4 (9006) NHP	93116515	BP	1/3 set	Auto Headlamp	Yes	12,8	51W	80	T4	P22d	C-8	1,24	3,13	175	306
HB4 (9006) NHX	93116383	PB	1/3 set	Auto Headlamp	Yes	12,8	51W	80	T4	P22d	C-8	1,24	3,13	125	306
9006XS LL	93116312	BP	1/6	Auto Headlamp	Yes	12,8	51W	80	T4	P22d straight	C-8	1,24	3,13	1000	306
9006XS LL	93116282	Boxed	1/10												
HB5 (9007)	93116333	BP	1/6	Auto Headlamp	Yes	12,8	65/55W	107/80	T4 3/4	PX29t	C-8/C-8	1,75	4,17	320/650	306
HB5 (9007)	93116501	BP	1/3 set												
HB5 (9007)	93116361	Boxed	1/10												
HB5 (9007) LL	93116314	BP	1/6	Auto Headlamp	Yes	12,8	65/55W	107/80	T4 3/4	PX29t	C-8/C-8	1,75	4,17	350/1800	306
HB5 (9007) NH	93116346	BP	1/6	Auto Headlamp	Yes	12,8	65/55W	107/80	T4 3/4	PX29t	C-8/C-8	1,75	4,17	160/320	306
HB5 (9007) NH	93116505	BP	1/3 set												
HB5 (9007) NHP	93116516	BP	1/3 set	Auto Headlamp	Yes	12,8	65/55W	107/80	T4 3/4	PX29t	C-8/C-8	1,75	4,17	100/200	306
HB5 (9007) NHX	93116384	PB	1/3 set	Auto Headlamp	Yes	12,8	65/55W	107/80	T4 3/4	PX29t	C-8/C-8	1,75	4,17	100/200	306
H13 (9008)	93116342	BP	1/6	Auto Headlamp	Yes	12,8	60/55W	119/80	T4 5/8	P26.4t	C-8/C-8	1	3,54	300/1500	306
H13 (9008)	93116362	Boxed	1/10												
H13 (9008) NH	93116519	BP	1/3 set	Auto Headlamp	Yes	12,8	65/55W	119/80	T4 5/8	P26.4t	C-8/C-8	1	3,54	160/400	306
H13 (9008) NHP	93116518	BP	1/3 set	Auto Headlamp	Yes	12,8	65/55W	119/80	T4 5/8	P26.4t	C-8/C-8	1	3,54	100/200	306
H13 (9008) NHX	93116376	PB	1/3 set	Auto Headlamp	Yes	12,8	65/55W	119/80	T4 5/8	P26.4t	C-8/C-8	1	3,54	100/200	306
HIR2 (9012)	93116352	BP	1/6	Auto Headlamp	Yes	12,8	55W	135	T3 1/4	PX22D	C-8	1,25	2,8	350	304
H10 (9145)	93116339	BP	1/6	Auto Fog		12,8	42W	65	T4	PY20D	C-8	1,24	3,01	1500	306
LED H7	93116081	PB	1/4 set	Auto Fog		12	18W	-	LED	PX26d	-	0,98	3,15		311
LED H7 FAN	93116082	PB	1/4 set	Auto Fog		12	24W	-	LED	PX26d	-	0,98	3,05		311
LED H8/H11	93116083	PB	1/4 set	Auto Fog		12	18W	-	LED	PGJ19-1 & PGJ19-2	-	1,07	3,05		311
LED H8/H11 FAN	93116084	PB	1/4 set	Auto Fog		12	24W	-	LED	PGJ19-1 & PGJ19-2	-	1,07	2,85		311
LED 9006	93116085	PB	1/4 set	Auto Fog		12	18W	-	LED	P22d	-	1,24	3,05		311
LED 9006 FAN	93116086	PB	1/4 set	Auto Fog		12	24W	-	LED	P22d	-	1,24	2,85		311
LED 168, 194, W5W 6K	93117370	BP	1/6 set	Auto Mini		12	.27A	-	LED	Wedge (W2.1x9.2d)	-	-	1,05		312
LED 211-2, 212-2 6K	93117373	BP	1/6 set	Auto Mini		12	0.5W	-	LED	Miniature Cap	-	-	1,72		312
LED 3156, 3155 4K	93116747	BP	1/6	Auto Exterior		12	3W	-	LED	Plastic Wedge (W2.5x16q)	-	-	2,05		312
LED 3156, 3155 6K	93116746	BP	1/6	Auto Exterior		12	3W	-	LED	Plastic Wedge (W2.5x16q)	-	-	2,05		312
LED 3157, 4157 4K	93116749	BP	1/6	Auto Exterior		12	3/.55W	-	LED	Plastic Wedge (W2.5x16q)	-	-	2,05		312
LED 3157, 4157 6K	93116748	BP	1/6	Auto Exterior		12	3/.55W	-	LED	Plastic Wedge (W2.5x16q)	-	-	2,05		312
LED 7440, W21W 4K	93116741	BP	1/6	Auto, Japanese Vehicles		12	3W	-	LED	Wedge (W3x16d)	-	-	1,9		312

For the most up-to-date product information, see www.tungsr.com.

Miniature and Headlight Lamps (continued)

Lamp No.	Order Code	Pack Type	Case Qty	Primary Application	DOT	Volts	Amps (A) or Watts (W)	MSCP	Bulb	Base	Filament	LCL (in)	MOL (in)	Rated Life (hrs)	Warning and Caution Notices
LED 7440, W21W 6K	93116740	BP	1/6	Auto, Japanese Vehicles		12	3W	-	LED	Wedge (W3x16d)	-	-	1,9		312
LED 7440R, W21WR	93116744	BP	1/6	Auto, Japanese Vehicles		12	3W	-	LED	Wedge (W3x16d)	-	-	1,9		312
LED 7443, W21/5W 4K	93116743	BP	1/6	Auto, Japanese Vehicles		12	3/.55W	-	LED	Wedge (W3x16q)	-	-	1,9		312
LED 7443, W21/5W 6K	93116742	BP	1/6	Auto, Japanese Vehicles		12	3/.55W	-	LED	Wedge (W3x16q)	-	-	1,9		312
LED 7443R, W21/5WR	93116745	BP	1/6	Auto, Japanese Vehicles		12	3/.55W	-	LED	Wedge (W3x16q)	-	-	1,9		312
LED DE3021, DE3022 6K	93117369	BP	1/6	Auto Mini		12	0.07W	-	LED	Festoon (SV7MM)	-	-	1,1		312
LED DE3175 6K	93117371	BP	1/6	Auto Mini		12	0.07W	-	LED	Festoon (SV8.5/8)	-	-	1,22		312
LED DE3425, C5W 6K	93117372	BP	1/6 set	Auto Mini		12	0.07W	-	LED	Festoon (SV8.5-8)	-	-	1,5		312
LED P21/5W, 1157, 2057 4K	93116737	BP	1/6	Auto Exterior		12	3/.55W	-	LED	Double Contact Index (BAY15d)	-	-	1,65		312
LED P21/5W, 1157, 2057 6K	93116736	BP	1/6	Auto Exterior		12	3/.55W	-	LED	Double Contact Index (BAY15d)	-	-	1,65		312
LED P21/5WR, 1157R, 2057R	93116739	BP	1/6	Auto Exterior		12	3/.55W	-	LED	Double Contact Index (BAY15d)	-	-	1,65		312
LED P21W, 1156, 1141 4K	93116735	BP	1/6	Auto Exterior		12	21W	-	LED	Double Contact Index (BAY15d)	-	-	1,65		312
LED P21W, 1156, 1141 6K	93116734	BP	1/6	Auto Exterior		12	21W	-	LED	Double Contact Index (BAY15d)	-	-	1,65		312
LED P21WR, 1156R, 1141R	93116738	BP	1/6	Auto Exterior		12	21W	-	LED	Single Contact Bayonet (BA15s)	-	-	1,65		312
P21/4W	93116468	BP	1/6 set	Auto Exterior		13,5	21/4W	35/1	S8	Double Contact Index (BAY15d)	C-6/C-6	1,25	2	450/1765	-
P21/5W	93116466	BP	1/6 set	Auto Exterior		13,5	21/5W	35/3	S8	Double Contact Index (BAY15d)	C-6/C-6	1,25	2	450/1860	-
P21/5W	93116002	Boxed	1/10/50												
P21/5W NH	93116414	BP	1/6 set	Auto Exterior		13,5	21/5W	35/3	S8	Double Contact Index (BAY15d)	C-6/C-6	1,25	2	145/1445	-
P21W	93116467	BP	1/6 set	Auto Exterior		13,5	21W	37	S8	Single Contact Bayonet (BA15s)	C-6	1,25	2	450	-
P21W NH	93116415	BP	1/6 set	Auto Exterior		13,5	21W	37	S8	Single Contact Bayonet (BA15s)	C-6	1,25	2	290	-
P21W 24V HD	93116058	Boxed	1/10/50	EU bus, trucks		28	21W	37	S8	Single Contact Bayonet (BA15s)	C-6	1,25	2	320	-
PY21W	93116470	BP	1/6 set	Auto Exterior		13,5	21W	22	S8	Single Contact Bayonet (BA15s)	C-6	1,25	2	450	-
R5W	93116454	BP	1/6 set	Auto Exterior		13,5	5W	4	G6	Single Contact Bayonet (BA15s)	C-2R	0,75	1,47	360	-
R10W	93116455	BP	1/6 set	Auto Exterior		13,5	10W	10	G6	Single Contact Bayonet (BA15s)	C-2R	0,75	1,47	890	-
T4W	93116482	BP	1/6 set	Auto Mini		13,5	4W	2,8	T2 3/4	Miniature Bayonet (Ba9s)	C-2R	0,59	1,08	680	-
W5W	93116489	BP	1/6 set	Auto Mini		13,5	5W	4	T3 1/4	Wedge (W2.1x9.5d)	C-2V	0,5	1,06	950	-
W5W LL	93116804	BP	1/6 set	Auto Mini		13,5	5W	4	T3 1/4	Wedge (W2.1x9.5d)	C-2V	0,5	1,06	1860	-

For the most up-to-date product information, see www.tungsr.com.

WARNING AND CAUTION NOTICES

Sealed Beam and Automotive Lamps

Lamp No.	Order Code	Pack Type	Case Qty	Primary Application	DOT	Volts	Watts (W)	MBCP	Spread to 10% MBCP		Bulb	Base	MOL (in)	Rated Life (hrs)	Warning and Caution Notices
									Horizontal	Vertical					
4405	93115717	Boxed	1/12	Spotlamp		12,8	30	50000	6°	5°	PAR36 (114mm; 4 1/2 in)	Screw Terminals	2,75	100	-
4416	93115716	Boxed	1/12	Spotlamp, Signal		12,8	30	35000	11°	4°	PAR36 (114mm; 4 1/2 in)	Screw Terminals	2,75	300	-
4505	93115718	Boxed	1/12	Aircraft Navigation		28	50	45000	11°	5°	PAR36 (114mm; 4 1/2 in)	Screw Terminals	2,75	400	-
4509	93115719	Boxed	1/12	Aircraft Landing Spotlamp		13	100	110000	12°	6°	PAR36 (114mm; 4 1/2 in)	Screw Terminals	2,75	25	-
4515	93115720	Boxed	1/12	Spotlamp		6,4	30	55000	5°	5°	PAR36 (114mm; 4 1/2 in)	Screw Terminals	2,75	100	-
4537	93115721	Boxed	1/12	Aircraft Landing		13	100	200000	11°	6°	PAR46 (146mm; 5 3/4 in)	Screw Terminals	3,13	25	-
4880	93115722	Boxed	1/12	C.I.M. Headlamp		28	60	6000	-	-	PAR46 (146mm; 5 3/4 in)	2 Contact Lugs	4	800	-
4411-3	93115726	Boxed	1/12	Tractor		12,8	35	3000	Trapezoidal	-	PAR36 (114mm; 4 1/2 in)	Combination	2,75	300	-
4537-2	93115728	Boxed	1/12	Spotlamp		13	100	200000	11°	6°	PAR46 (146mm; 5 3/4 in)	Screw Terminals	3,13	25	-
H4515	93115727	Boxed	1/12	Spotlamp, Shielded Bulb		6,4	30	67000	5.5°	4°	PAR36 (114mm; 4 1/2 in)	Screw Terminals	2,75	100	307
H4651	93115708	Boxed	1/6	Headlamp, HB, Type 1A1	Y	12,8	50	SAE	-	-	165mm (Rectangular 4x6)	2 Contact Lugs	4,8	200	307
H4656	93115709	Boxed	1/6	Headlamp, HB/LB, Type 2A1	Y	12,8	35/35	SAE	-	-	165mm (Rectangular 4x6)	3 Contact Lugs	4,8	200/320	307
H4656 NH	93115724	Boxed	1/6	Headlamp, HB/LB, Type 2A1	Y	12,8	35/35	SAE	-	-	165mm (Rectangular 4x6)	3 Contact Lugs	4,8	200/700	307
H4666/H4668	93115711	Boxed	1/6	Headlamp, HB/LB, Type 2E1	Y	12,8	65/55	SAE	-	-	165mm (Rectangular 4x6)	3 Contact Lugs	4,8	150/320	307
H5024	93115714	Boxed	1/6	Headlamp, HB/LB, Type 2D1	Y	12,8	65/42	SAE	-	-	PAR 56 (178mm, 7 in)	3 Contact Lugs	5	400/2000	307
H5051	93115712	Boxed	1/6	Headlamp, HB, Type 1A1	Y	12,8	50	SAE	-	-	165mm (Rectangular 4x6)	2 Contact Lugs	4,8	500	307
H5054	93115715	Boxed	1/6	Headlamp, HB/LB, Type 2B1	Y	12,8	65/42	SAE	-	-	200mm (Rectangular 5x7)	3 Contact Lugs	5,44	400/2000	307
H5062	93115713	Boxed	1/6	Headlamp, HB/LB, Type 2A1	Y	12,8	40/55	SAE	-	-	165mm (Rectangular 4x6)	3 Contact Lugs	4,8	400/2000	307
H6024	93115707	Boxed	1/6	Headlamp, HB/LB, Type 2D1	Y	12,8	65/35	SAE	-	-	PAR 56 (178mm, 7 in)	3 Contact Lugs	5	150/320	307
H6024NH	93115725	Boxed	1/6	Headlamp, HB/LB, Type 2D1	Y	12,8	65/35	SAE	-	-	PAR 56 (178mm, 7 in)	3 Contact Lugs	5	150/350	307
H6054	93115710	Boxed	1/6	Headlamp, HB/LB Type 2B1	Y	12,8	65/35	SAE	-	-	200mm (Rectangular 5x7)	3 Contact Lugs	5,44	150/320	307
H6054 NH	93115723	Boxed	1/6	Headlamp, HB/LB Type 2B1	Y	12,8	65/35	SAE	-	-	200mm (Rectangular 5x7)	3 Contact Lugs	5,44	150/700	307
LED 7" ROUND	93112881	Boxed	1/6	Headlamp, HB/LB for 2D1	Y	12,8	37,8	SAE	-	-	PAR 56 (178mm, 7 in)	3 Contact Lugs	4,2	-	315
LED 5X7	93112882	Boxed	1/6	Headlamp, HB/LB for 2B1	Y	12,8	37,8	SAE	-	-	200mm (Rectangular 5x7)	3 Contact Lugs	4,4	-	315
LED 4X6 HIGH	93112884	Boxed	1/6	Headlamp, HB for 1A1	Y	12,8	13	SAE	-	-	165mm (Rectangular 4x6)	3 Contact Lugs	3,9	-	314
LED 4X6 LOW	93112883	Boxed	1/6	Headlamp, LB for 2A1	Y	12,8	16,3	SAE	-	-	165mm (Rectangular 4x6)	3 Contact Lugs	3,9	-	314

302

⚠ WARNING

Risk of fire

- Keep combustible materials away from lamp
- Use in fixture rated for this product

Unexpected lamp rupture may cause injury, fire, or property damage

- Avoid contact with glass during operation
- Avoid direct water/liquid contact
- Use in enclosed fixture rated for this product

304

⚠ WARNING

Risk of fire

- Keep combustible materials away from lamp
- Use in fixture rated for this product

Lamp emits UV radiation which may cause eye/skin injury

- Avoid exposure of eyes and skin to unshielded lamp

Pressurized lamp—unexpected rupture may cause injury, fire, or property damage

- Use eye protection when handling lamp
- Do not exceed rated voltage
- Do not touch glass with bare hands
- Do not use lamp if outer glass is scratched or broken
- Dispose of lamp in a closed container
- Do not turn on lamp until fully installed
- Keep away from children
- Use protective screen when handling

⚠ CAUTION

Risk of burn

- Allow lamp/fixture to cool before handling

For Best Performance

- Limit seal temperature to 350°C
- Maintain 250°C minimum bulb wall temperature
- Remove fingerprints from bulb with grease-free solvent
- Operate at design voltage

305

⚠ CAUTION

Lamp may shatter and cause injury if broken

- Do not use excessive force when installing lamp

306

⚠ WARNING

Pressurized lamp—unexpected rupture may cause injury, fire, or property damage

- Use eye protection when handling lamp
- Do not exceed rated voltage
- Avoid direct water/liquid contact
- Use in enclosed fixture rated for this product
- Do not use lamp if outer glass is scratched or broken
- Dispose of lamp in a closed container
- Do not turn on lamp until fully installed
- Keep away from children
- Use protective screen when handling

⚠ CAUTION

Risk of burn

- Allow lamp/fixture to cool before handling

307

⚠ WARNING

Pressurized lamp—unexpected rupture may cause injury, fire, or property damage

- Do not use lamp if outer glass is scratched or broken
- Dispose of lamp in a closed container

308

⚠ WARNING

Risk of fire

- Keep combustible materials away from lamp
- Use in fixture rated for this product

Pressurized lamp—unexpected rupture may cause injury, fire, or property damage

- Use eye protection when handling lamp
- Do not exceed rated voltage
- Do not touch glass with bare hands
- Do not use lamp if outer glass is scratched or broken
- Dispose of lamp in a closed container
- Do not turn on lamp until fully installed
- Keep away from children
- Use protective screen when handling

⚠ CAUTION

Risk of burn

- Allow lamp/fixture to cool before handling

For Best Performance

- Limit seal temperature to 350°C
- Maintain 250°C minimum bulb wall temperature
- Remove fingerprints from bulb with grease-free solvent
- Operate at design voltage

E10

⚠ WARNING

Risk of electric shock

- Turn power off before inspection, installation or removal

Risk of fire

- Use in fixture rated for this product

A damaged lamp emits UV radiation which may cause eye/skin injury

- Turn power off if glass bulb is broken. Remove and dispose of lamp
- Use eye protection when handling lamp
- Do not exceed rated voltage
- Do not touch glass with bare hands
- Avoid direct water/liquid contact
- Use in enclosed fixture rated for this product
- Do not use lamp if outer glass is scratched or broken
- Use only properly rated ballast
- Operate lamp only in specified position
- Do not use beyond rated life
- Do not turn on lamp until fully installed
- Do not use beyond rated life

WARNING AND CAUTION NOTICES CONT.

⚠ CAUTION

Risk of burn

- Allow lamp to cool before handling
- Do not turn on lamp until fully installed
- Turn power off before installing lamp

Turn power off before installing lamp

- Turn power off before installing lamp. Use only properly rated ballast

Lamp may shatter and cause injury if broken

- Wear safety glasses and gloves when handling lamp
- Do not use lamp if outer glass is scratched or broken
- Dispose of lamp in a closed container
- Remove and install by grasping only plastic portion of the lamp
- Do not use excessive force when installing lamp

Hg - LAMP CONTAINS MERCURY

Manage in Accord with Disposal Laws

See: www.lamprecycle.org or 1-800-435-4448

Lamp should be installed by an automotive service specialist.

311

- Not intended for use as headlamp. Use only as auxiliary lamp such as fog lamp

312

- After installation verify correct operation. In some vehicles the lower current draw may result in incorrect operation. In this case replace lamps.

313

⚠ WARNING

Risk of electric shock

- Turn power off before inspection, installation or removal

Risk of fire

- Use in fixture rated for this product

A damaged lamp emits UV radiation which may cause eye/skin injury

- Turn power off if glass bulb is broken. Remove and dispose of lamp.

Pressurized lamp--unexpected rupture may cause injury, fire, or property damage

- Use eye protection when handling lamp
- Do not exceed rated voltage
- Do not touch glass with bare hands
- Avoid direct water/liquid contact
- Use in enclosed fixture rated for this product
- Do not use lamp if outer glass is scratched or broken
- Use only properly rated ballast
- Operate lamp only in specified position
- Do not use beyond rated life
- Do not turn on lamp until fully installed
- Do not use beyond rated life

⚠ CAUTION

Risk of burn

- Allow lamp to cool before handling
- Do not turn on lamp until fully installed
- Turn power off before installing lamp

Turn power off before installing lamp

- Turn power off before installing lamp Use only properly rated ballast

Lamp may shatter and cause injury if broken

- Wear safety glasses and gloves when handling lamp
- Do not use lamp if outer glass is scratched or broken
- Dispose of lamp in a closed container
- Remove and install by grasping only plastic portion of the lamp
- Do not use excessive force when installing lamp

314

Replace lamps in pairs

- If replacing halogen lamps, the low beam halogen lamp must be replaced with the Tungsram low beam LED and the high beam halogen must be replaced with the Tungsram high beam LED lamp

Do not combine a LED high beam with a halogen low beam, or vice versa as the correct beam pattern will not be achieved

315

See installation instructions with lamp

TUNGSRAM™

Innovation is our heritage
EST. 1896

SEE AND BE SEEN

AUTOMOTIVE LAMPS

- Deliver outstanding performance for maximum visibility and increased safety.
- Standard and premium product lines feature absolute performance and unique technologies.

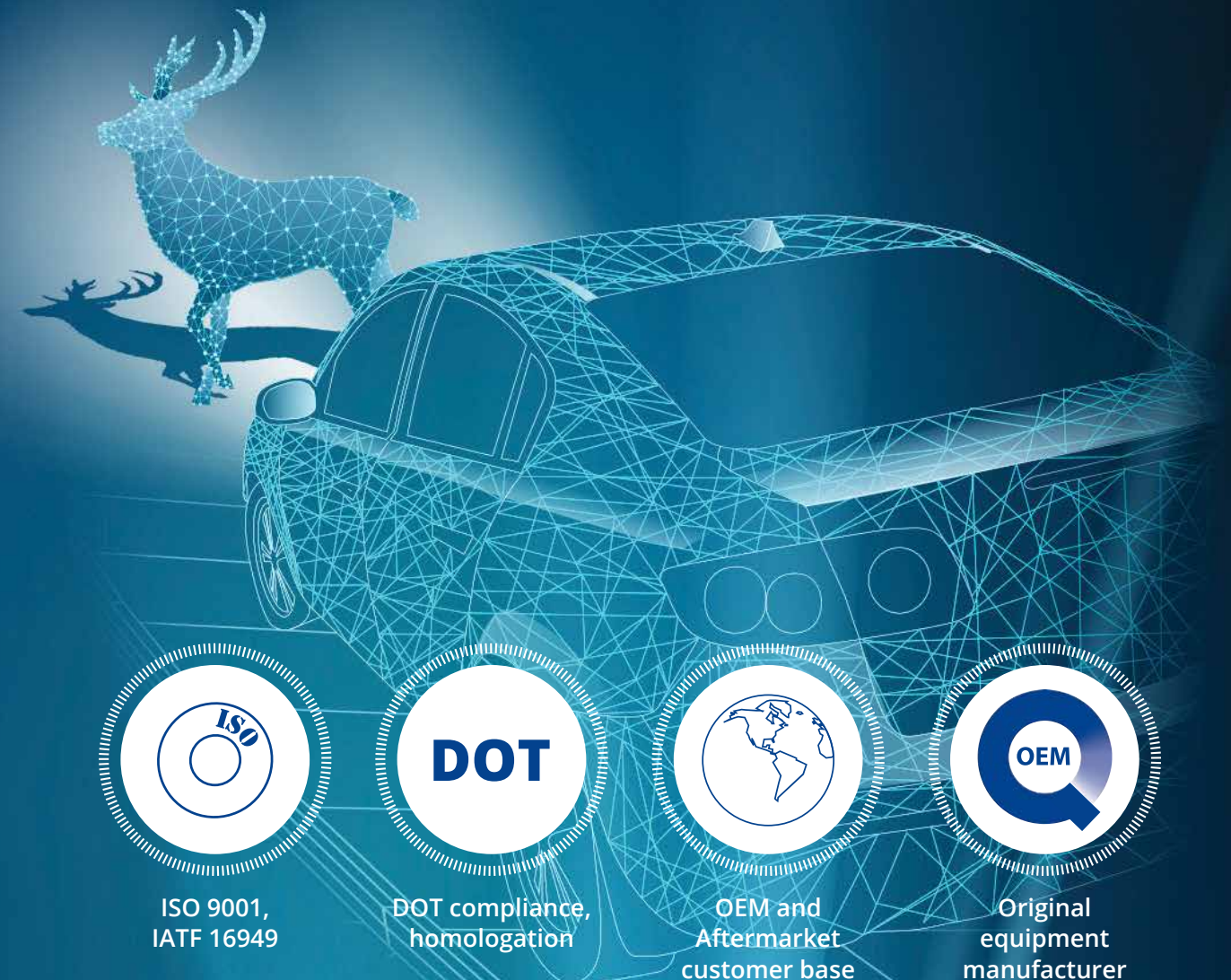

For the most up-to-date product information, see www.tungsram.com.



na.automotive.tungram.com

We in Tungram Operations Kft. are constantly developing and improving our products. For this reason, all product descriptions in this catalogue are intended as a general guide, and we may change specifications from time to time in the interest of product development, without prior notification or public announcement. All descriptions in this publication present only general particulars of the goods to which they refer and shall not form part of any contract. Data in this guide has been obtained in controlled experimental conditions. However, Tungram cannot accept any liability arising from the reliance on such data to the extent permitted by law.

03/2020